

# Translations (B)

Draw each translated image.

Translate by  $(1, 2)$ .

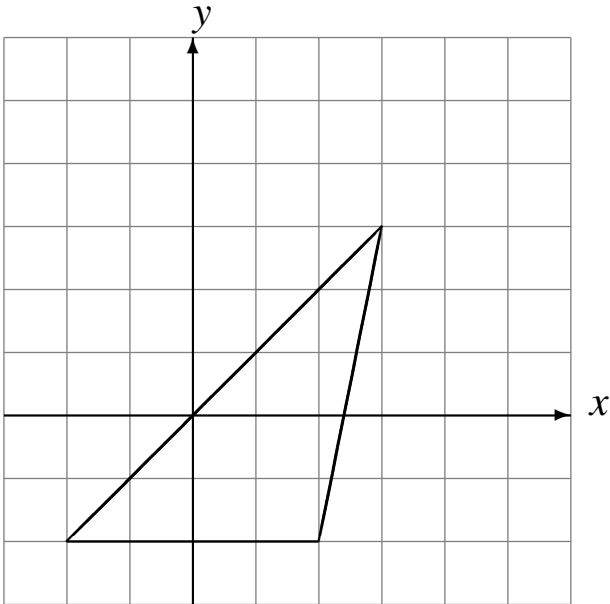

Translate by  $(-3, -3)$ .

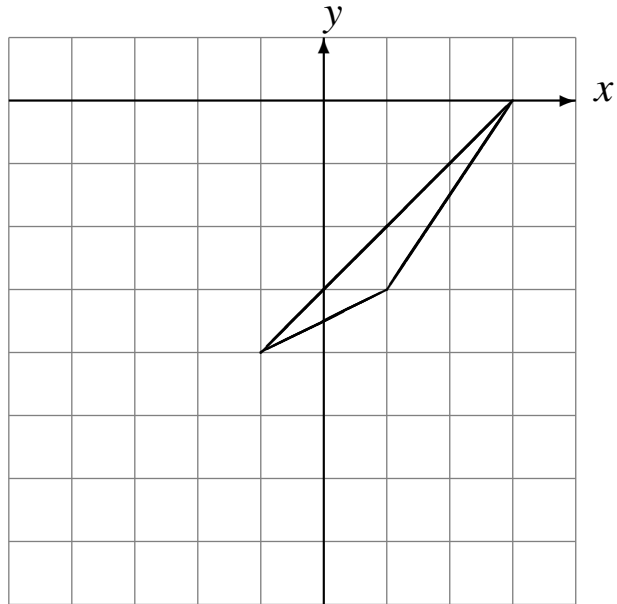

Translate by  $(3, 2)$ .

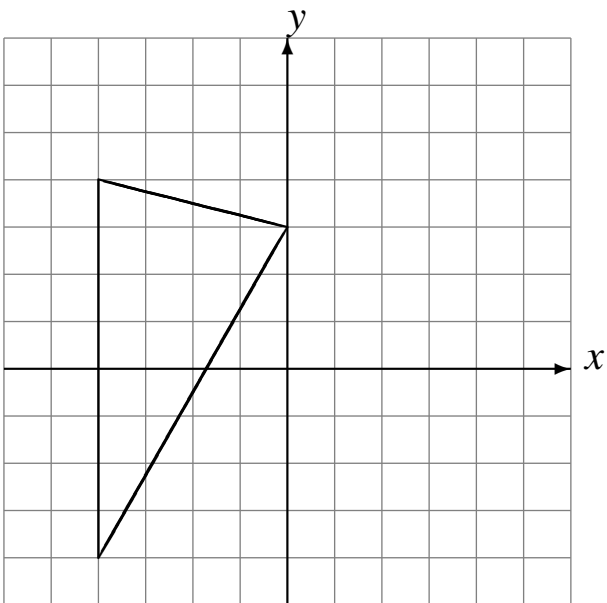

Translate by  $(1, 1)$ .

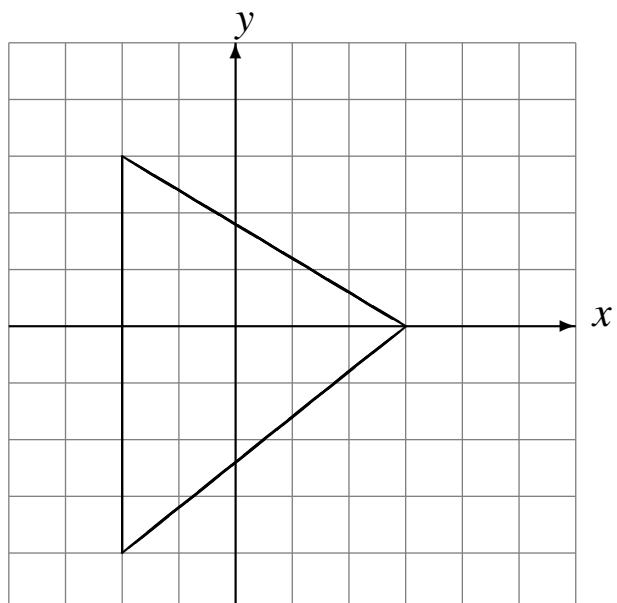

# Translations (B) Answers

Draw each translated image.

Translate by  $(1, 2)$ .

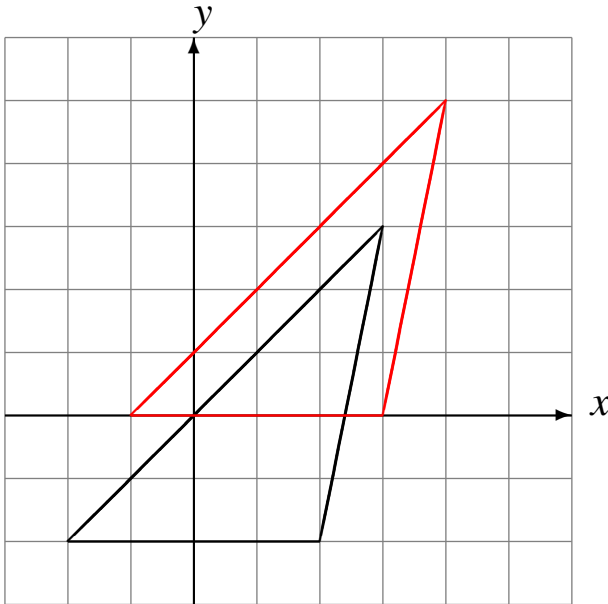

Translate by  $(-3, -3)$ .

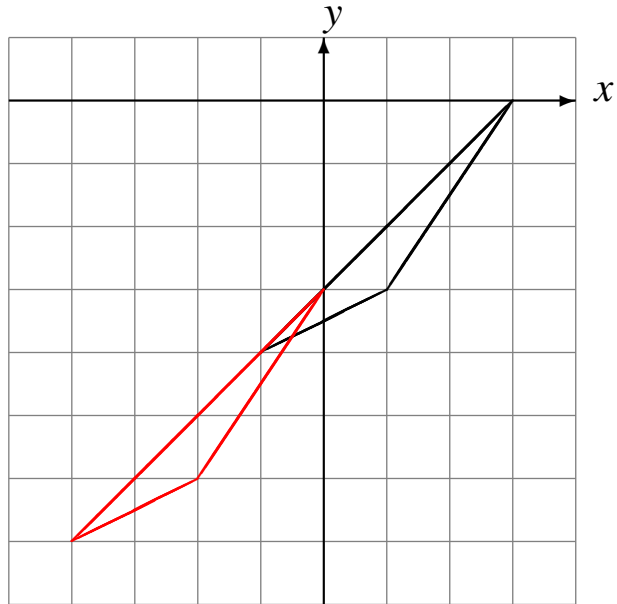

Translate by  $(3, 2)$ .

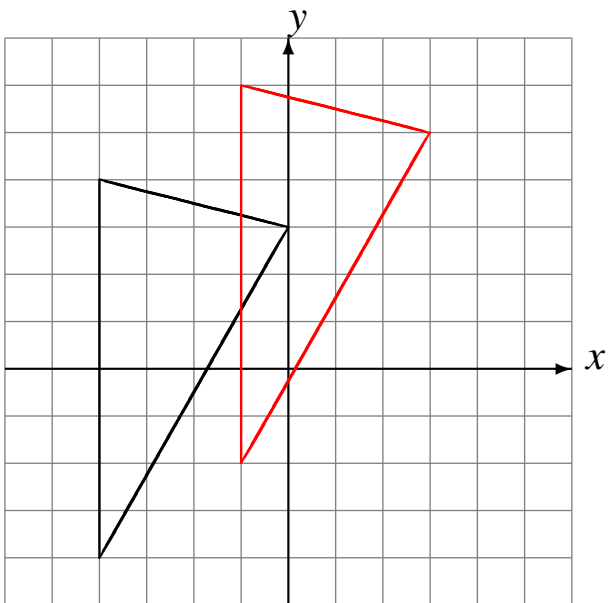

Translate by  $(1, 1)$ .

