

# Scale Factor (A)

Name: \_\_\_\_\_

Date: \_\_\_\_\_

Determine the scale factor for each pair of shapes and label the missing lengths.

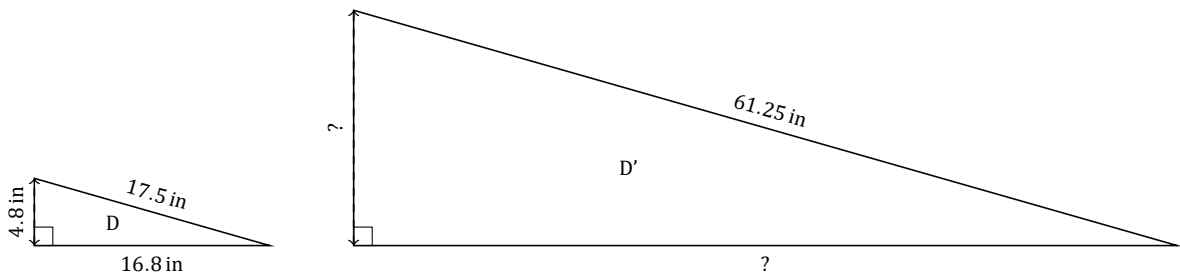
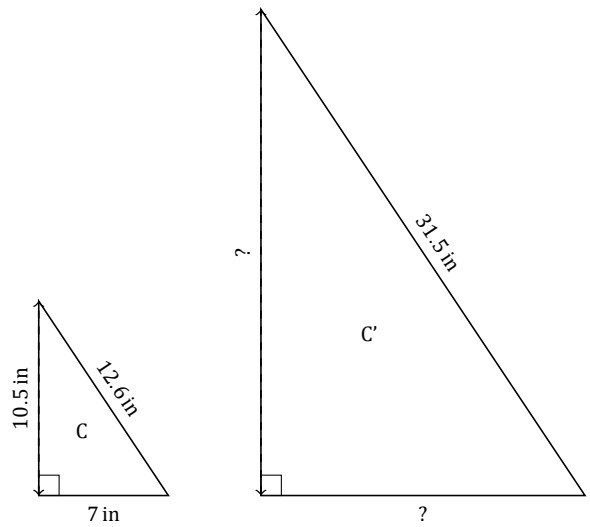
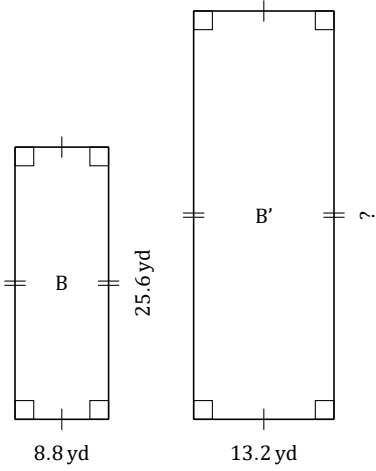
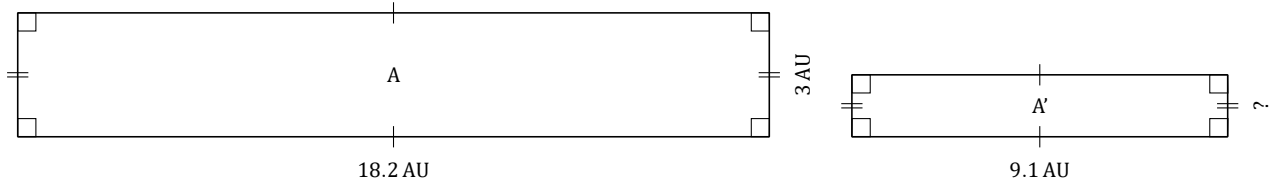

# Scale Factor (A) Answers

Name: \_\_\_\_\_

Date: \_\_\_\_\_

Determine the scale factor for each pair of shapes and label the missing lengths.

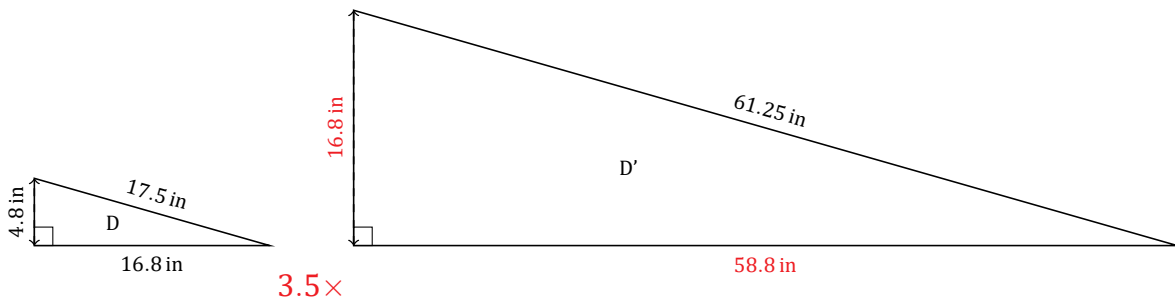
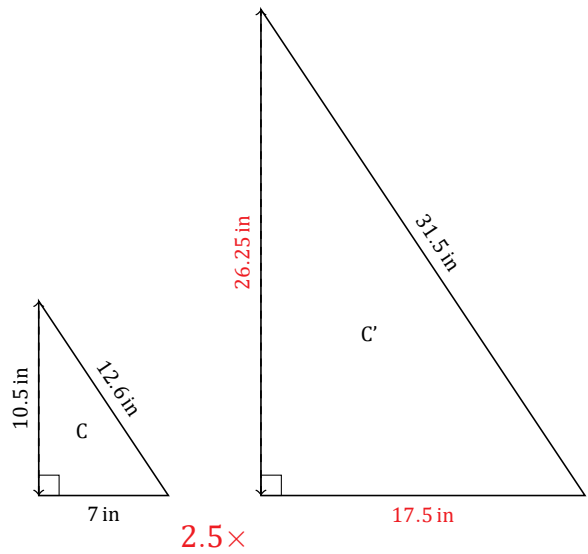
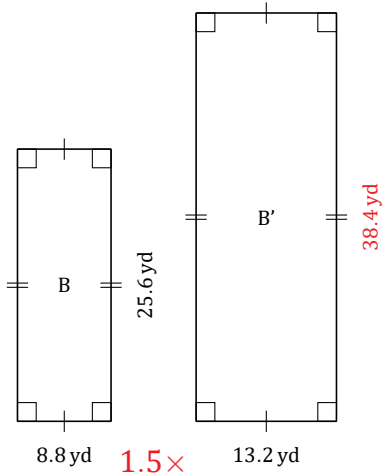
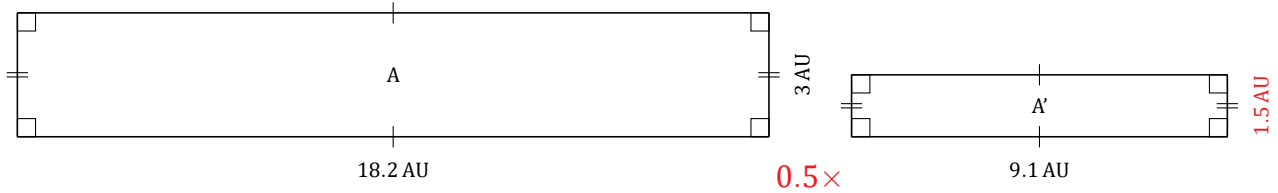

# Scale Factor (B)

Name: \_\_\_\_\_

Date: \_\_\_\_\_

Determine the scale factor for each pair of shapes and label the missing lengths.

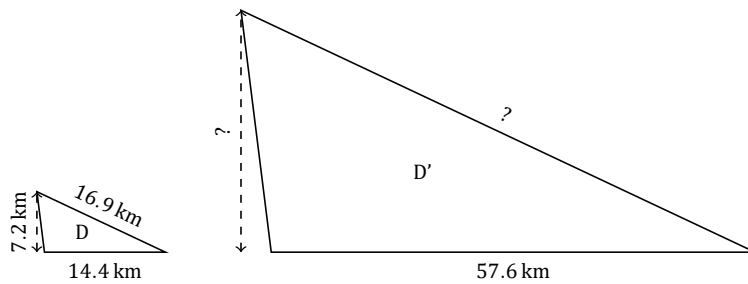
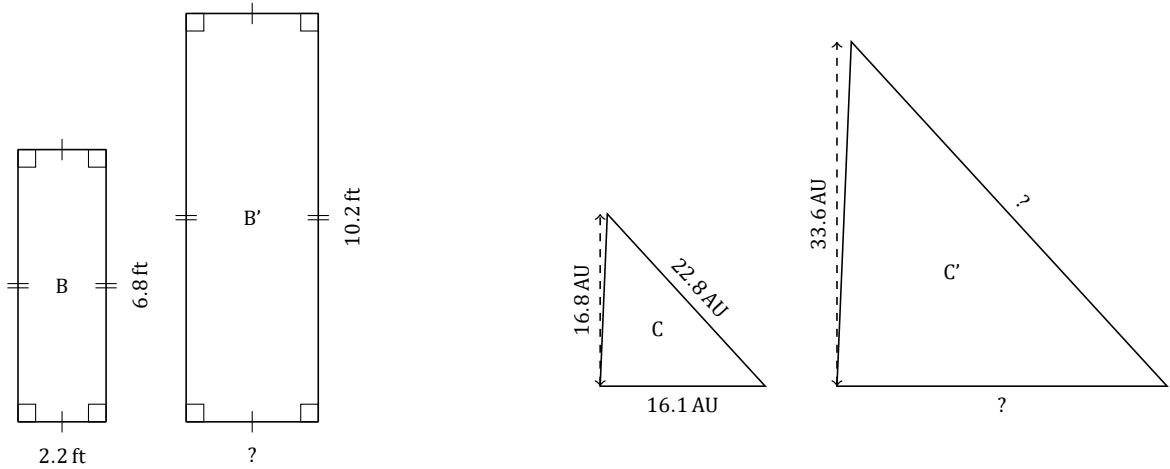
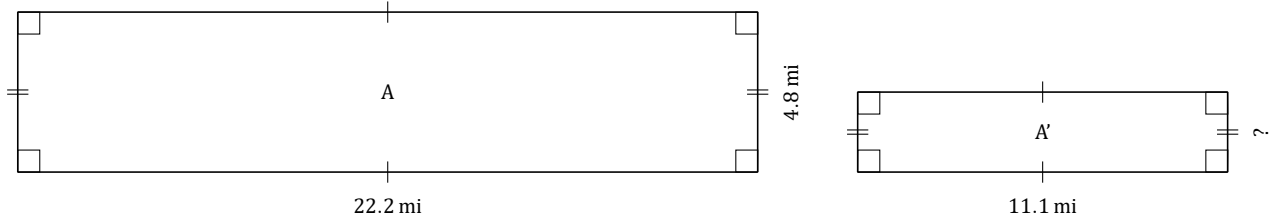

# Scale Factor (B) Answers

Name: \_\_\_\_\_

Date: \_\_\_\_\_

Determine the scale factor for each pair of shapes and label the missing lengths.

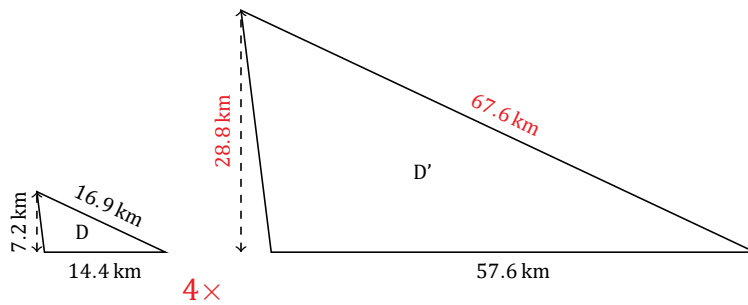
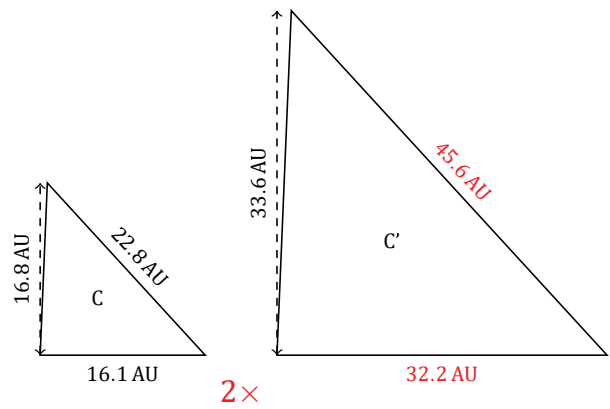
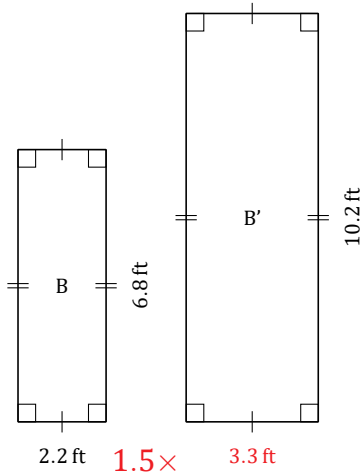
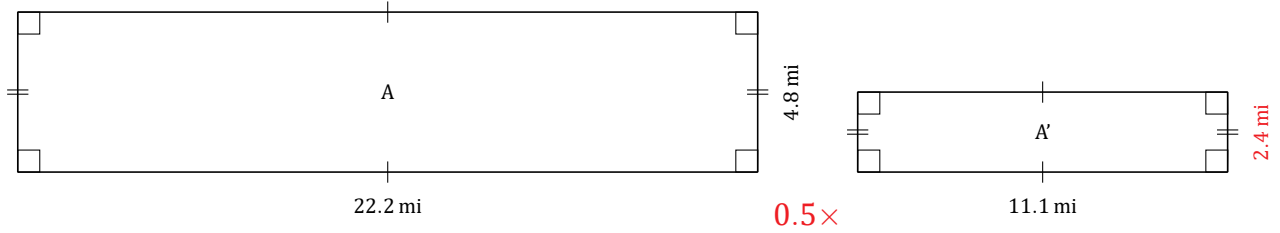

# Scale Factor (C)

Name: \_\_\_\_\_

Date: \_\_\_\_\_

Determine the scale factor for each pair of shapes and label the missing lengths.

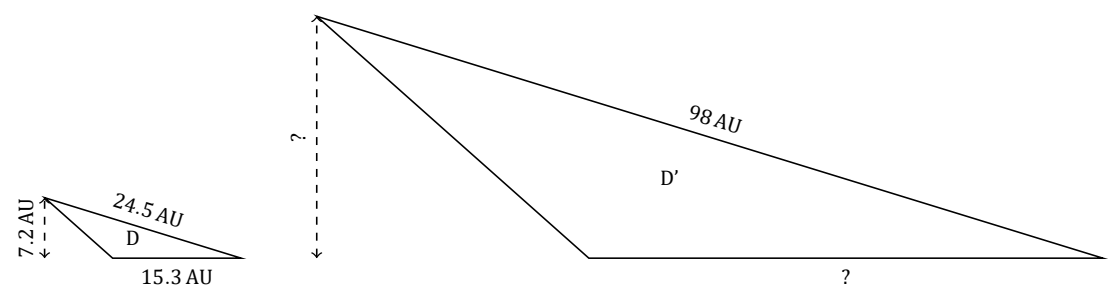
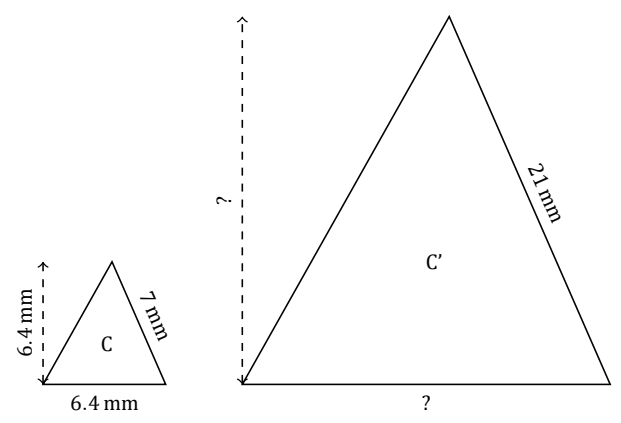
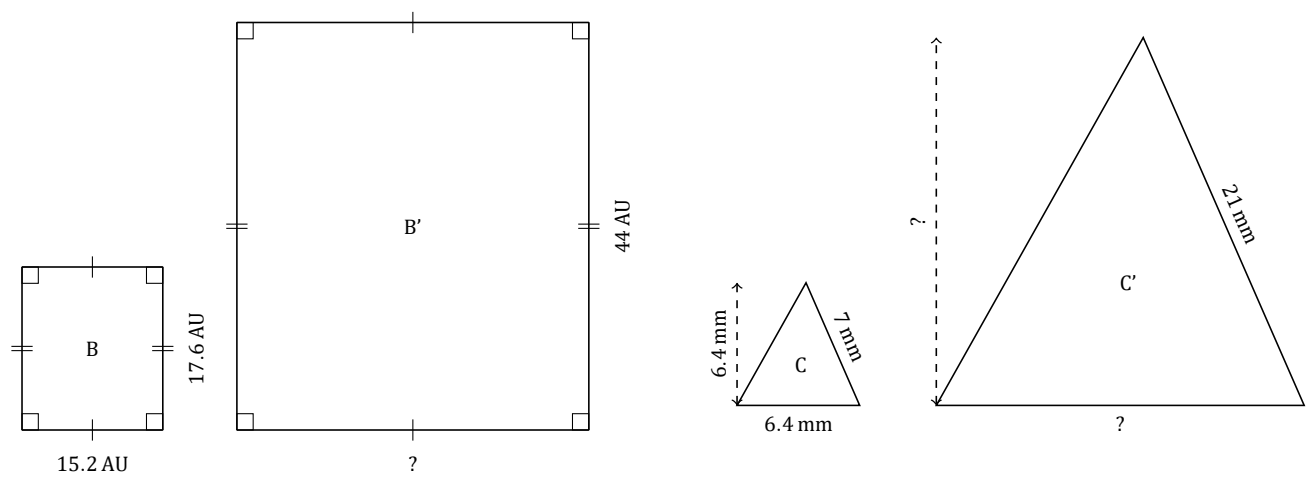
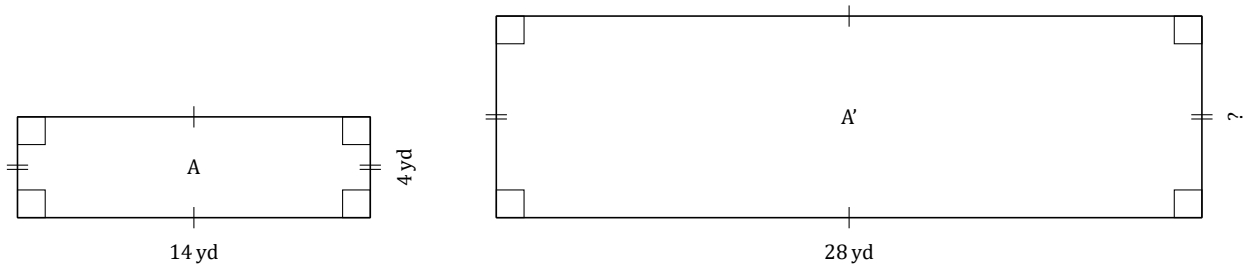

# Scale Factor (C) Answers

Name: \_\_\_\_\_

Date: \_\_\_\_\_

Determine the scale factor for each pair of shapes and label the missing lengths.

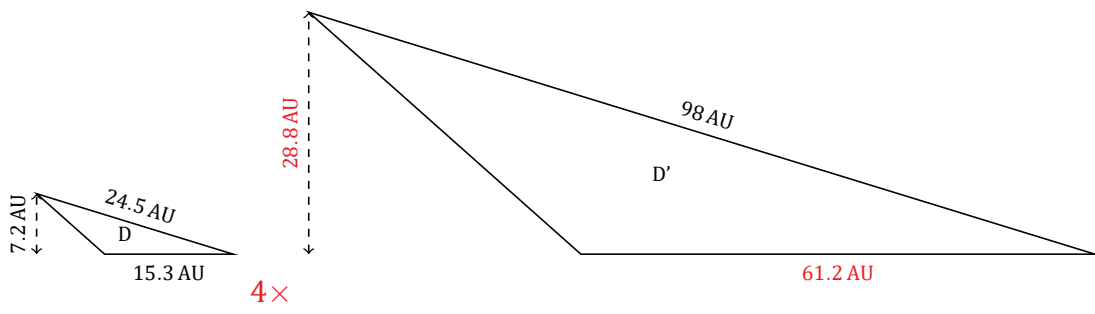
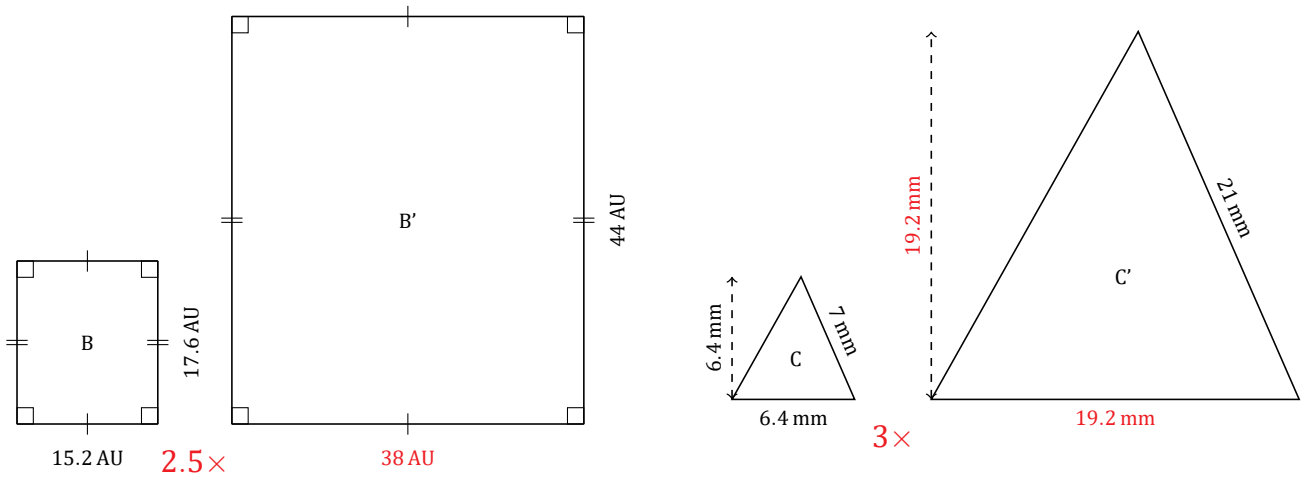
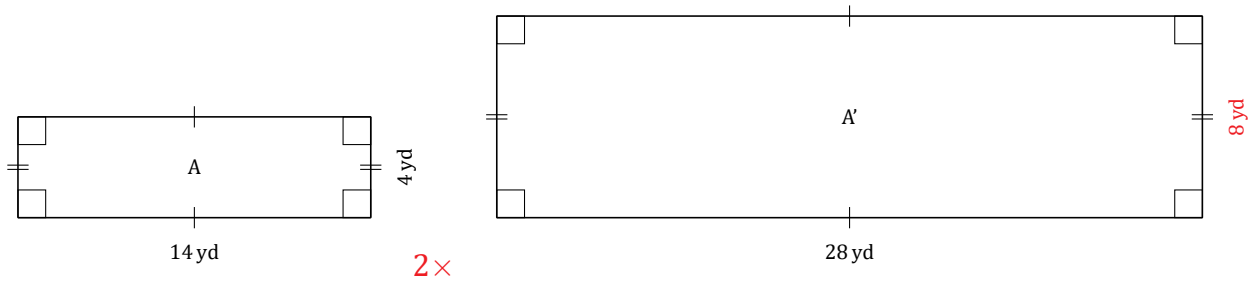

# Scale Factor (D)

Name: \_\_\_\_\_

Date: \_\_\_\_\_

Determine the scale factor for each pair of shapes and label the missing lengths.

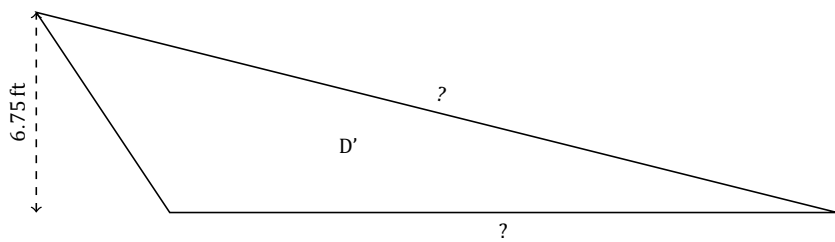
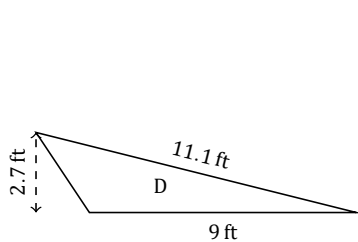
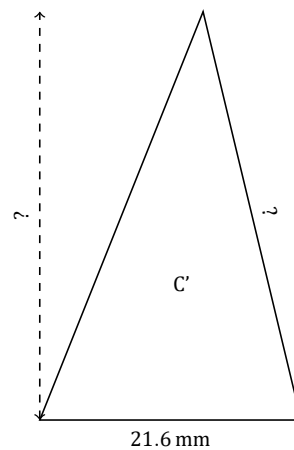
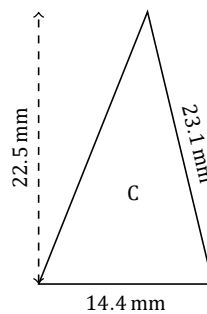
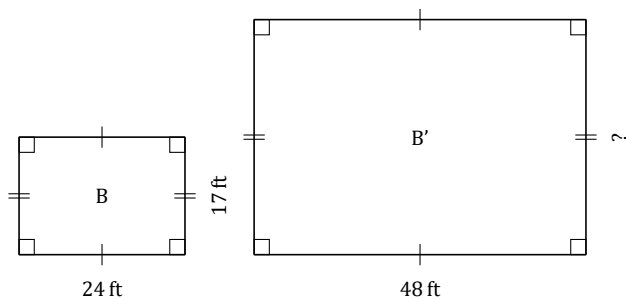
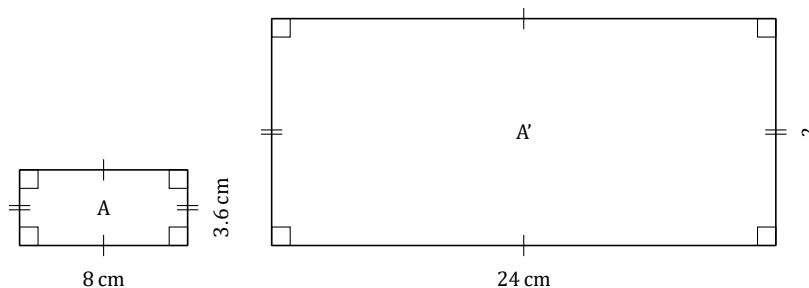

# Scale Factor (D) Answers

Name: \_\_\_\_\_

Date: \_\_\_\_\_

Determine the scale factor for each pair of shapes and label the missing lengths.

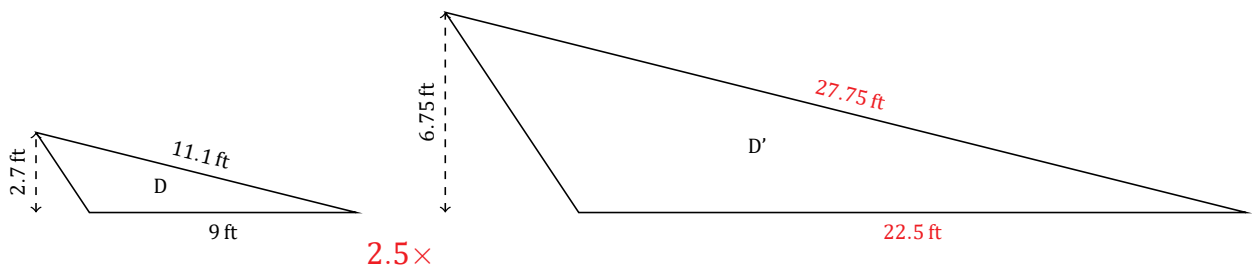
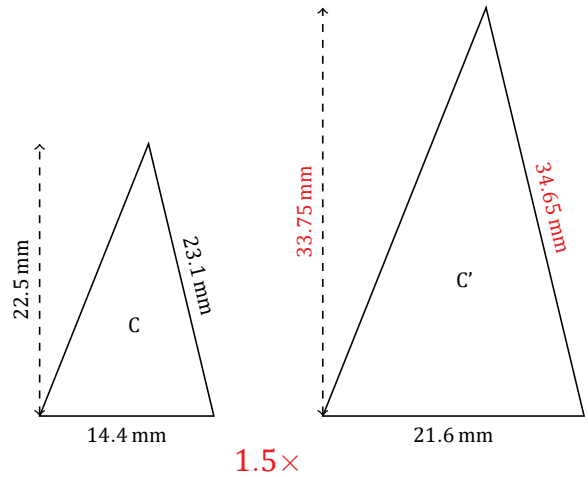
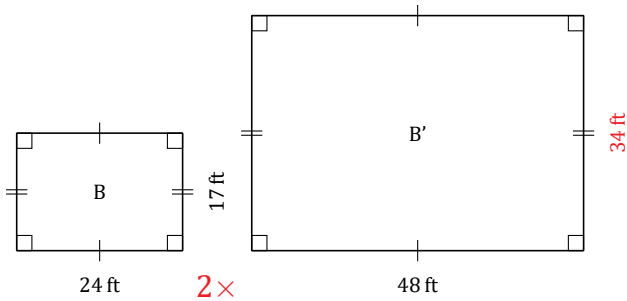
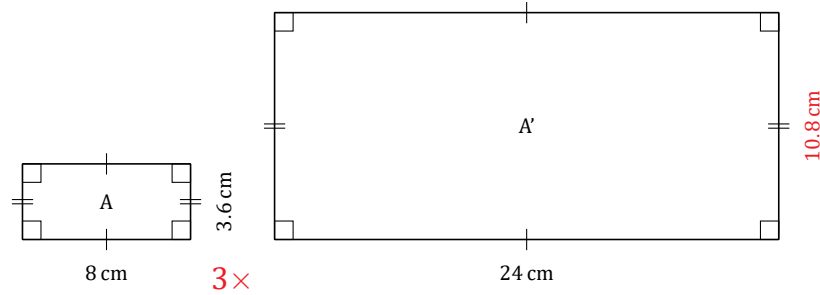



# Scale Factor (E)

Name: \_\_\_\_\_

Date: \_\_\_\_\_

Determine the scale factor for each pair of shapes and label the missing lengths.

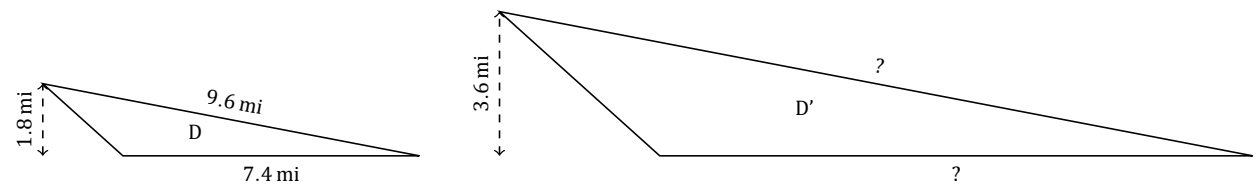
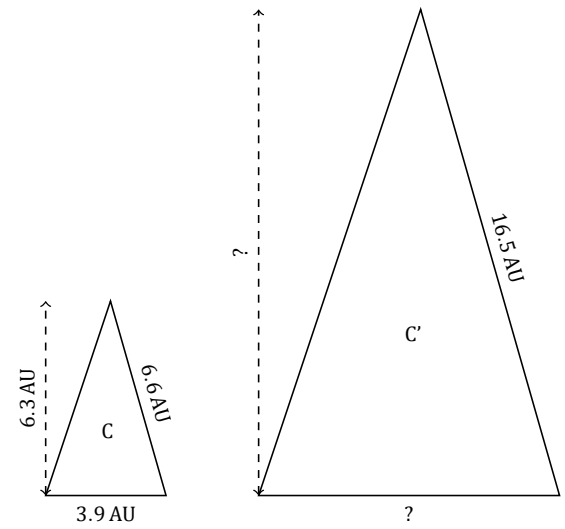
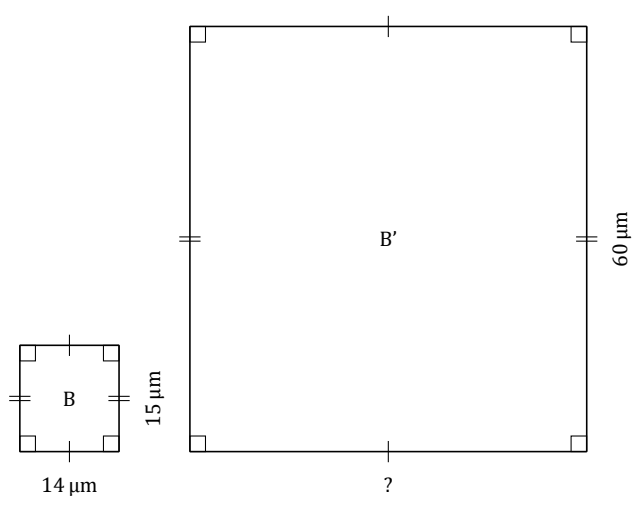
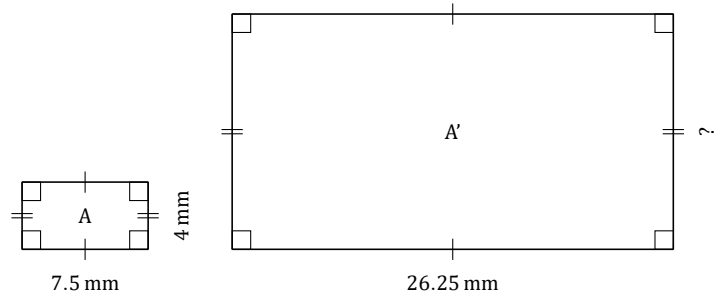

# Scale Factor (E) Answers

Name: \_\_\_\_\_

Date: \_\_\_\_\_

Determine the scale factor for each pair of shapes and label the missing lengths.

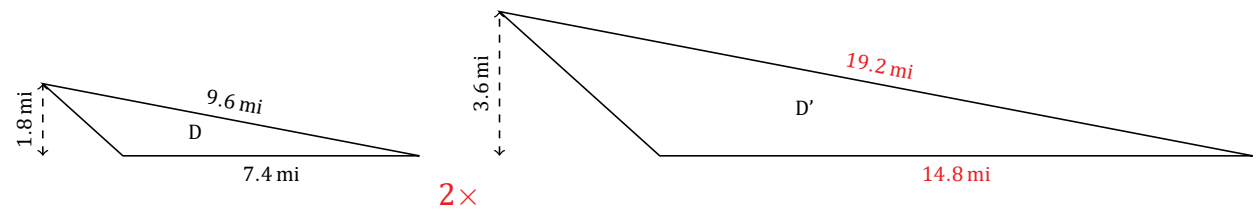
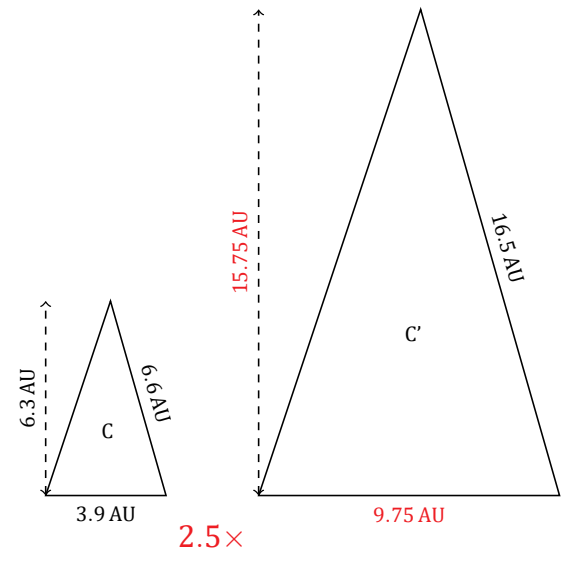
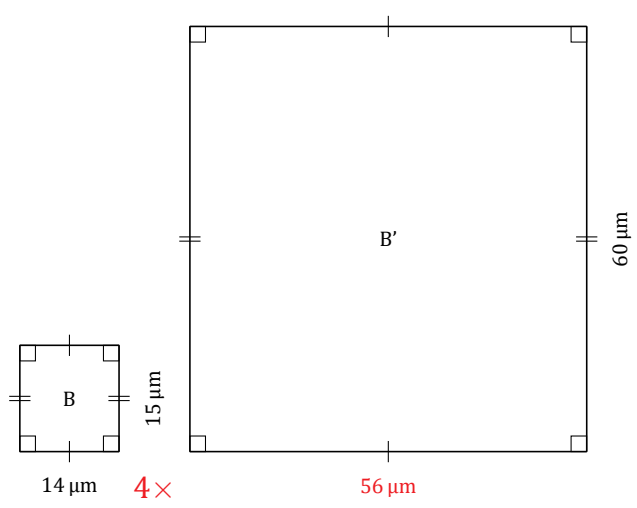
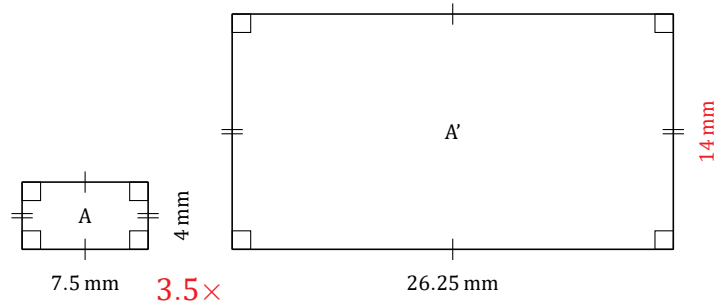

# Scale Factor (F)

Name: \_\_\_\_\_

Date: \_\_\_\_\_

Determine the scale factor for each pair of shapes and label the missing lengths.

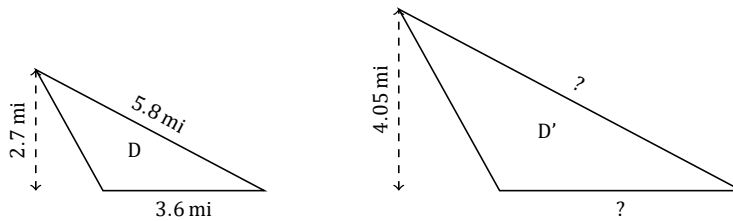
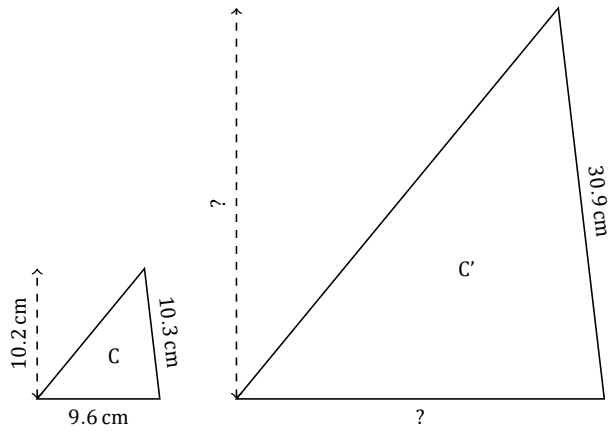
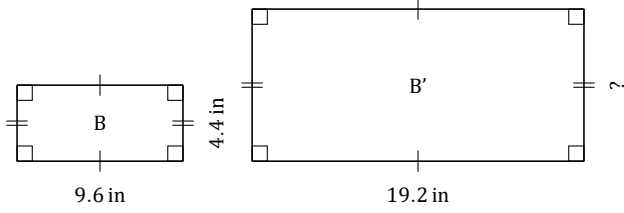
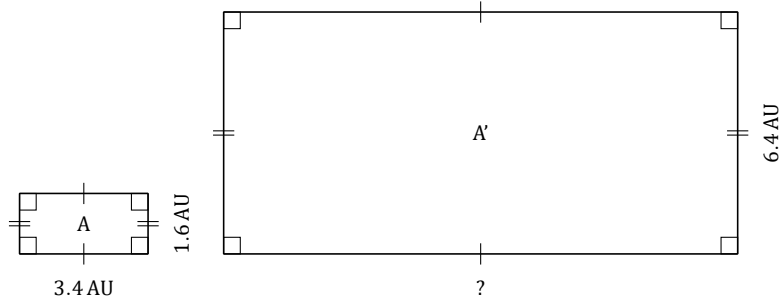

# Scale Factor (F) Answers

Name: \_\_\_\_\_

Date: \_\_\_\_\_

Determine the scale factor for each pair of shapes and label the missing lengths.

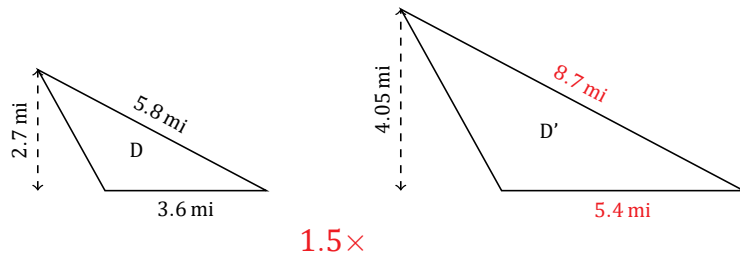
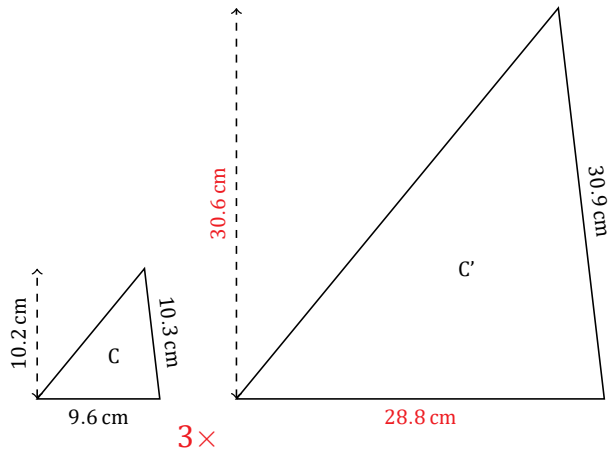
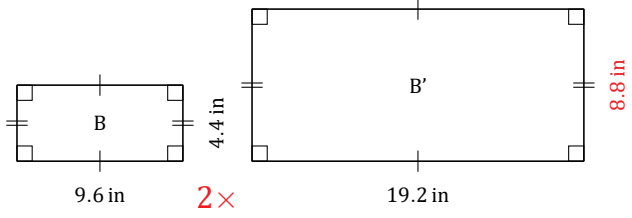
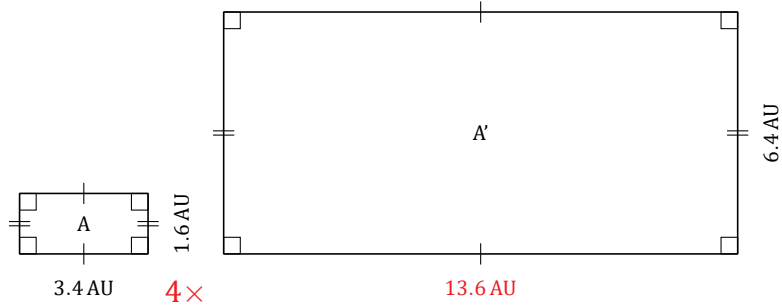

# Scale Factor (G)

Name: \_\_\_\_\_

Date: \_\_\_\_\_

Determine the scale factor for each pair of shapes and label the missing lengths.

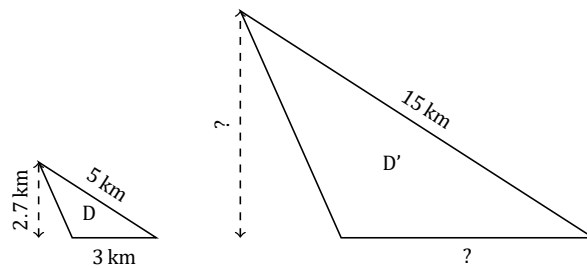
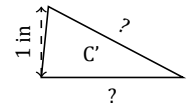
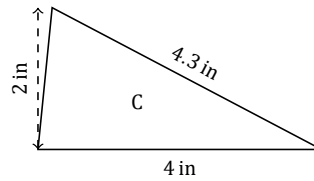
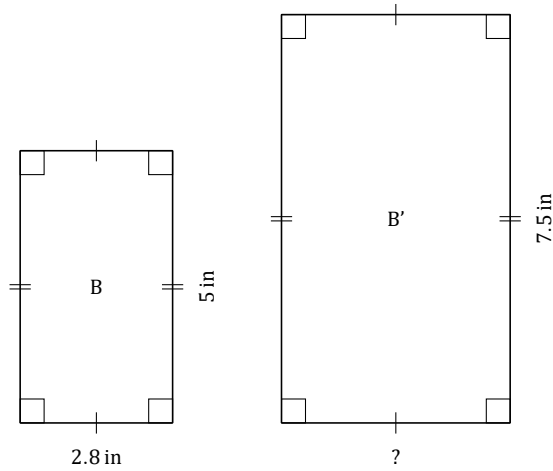
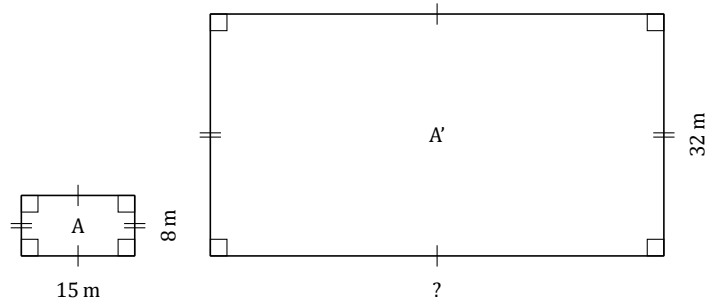

# Scale Factor (G) Answers

Name: \_\_\_\_\_

Date: \_\_\_\_\_

Determine the scale factor for each pair of shapes and label the missing lengths.

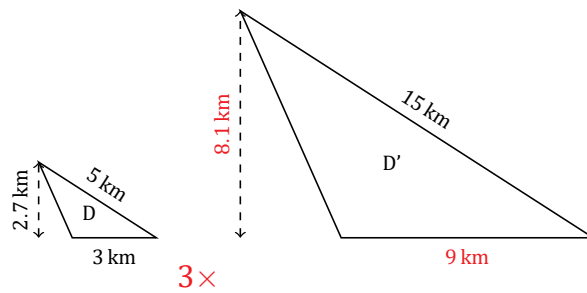
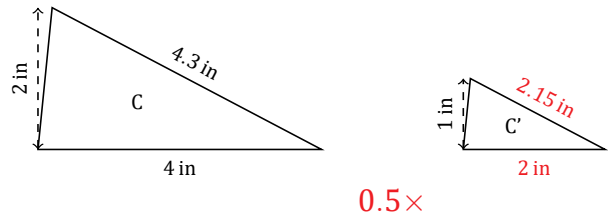
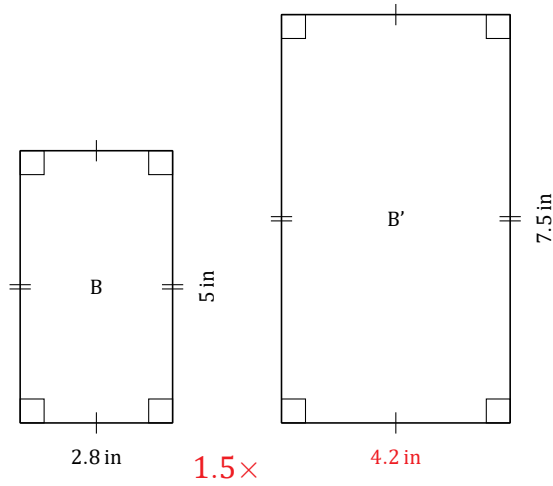
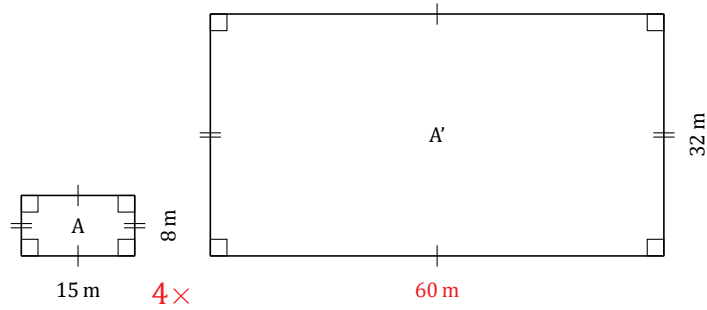

# Scale Factor (H)

Name: \_\_\_\_\_

Date: \_\_\_\_\_

Determine the scale factor for each pair of shapes and label the missing lengths.

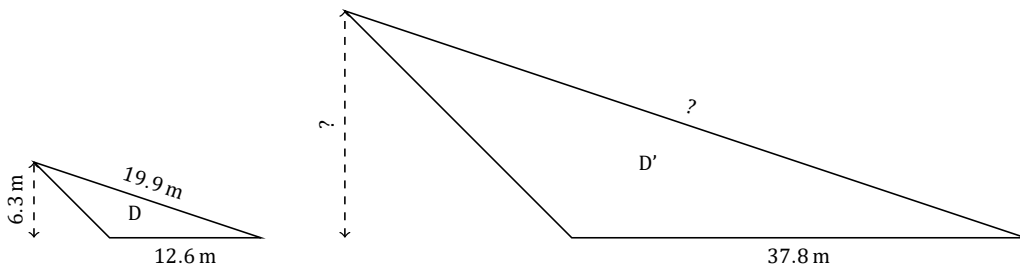
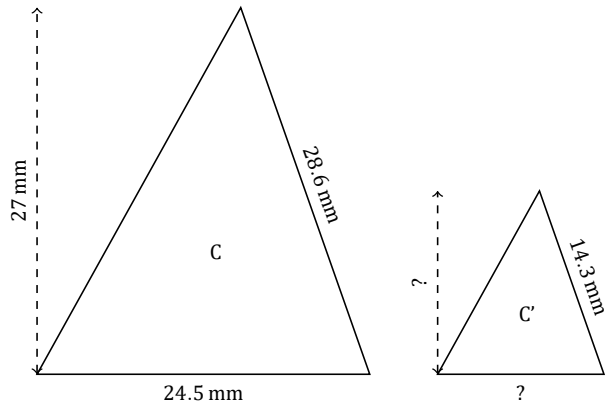
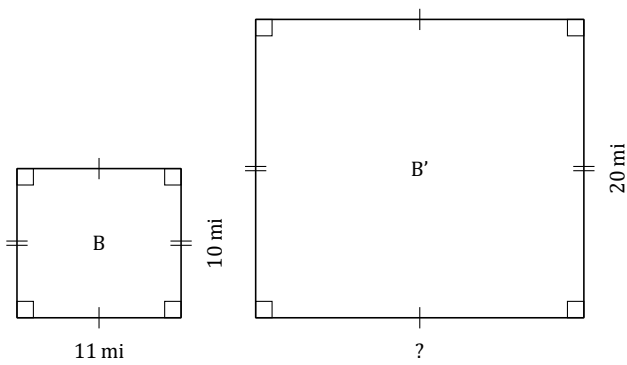
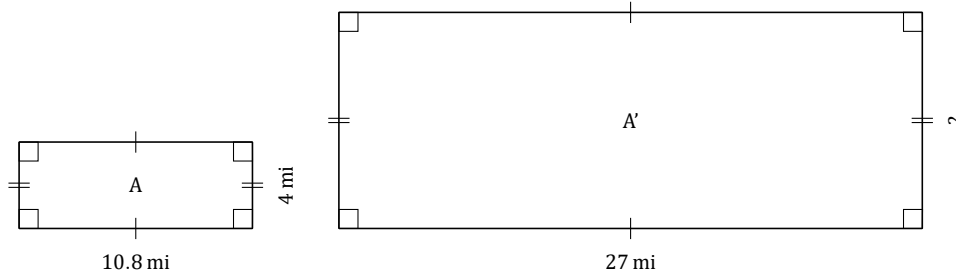

# Scale Factor (H) Answers

Name: \_\_\_\_\_

Date: \_\_\_\_\_

Determine the scale factor for each pair of shapes and label the missing lengths.

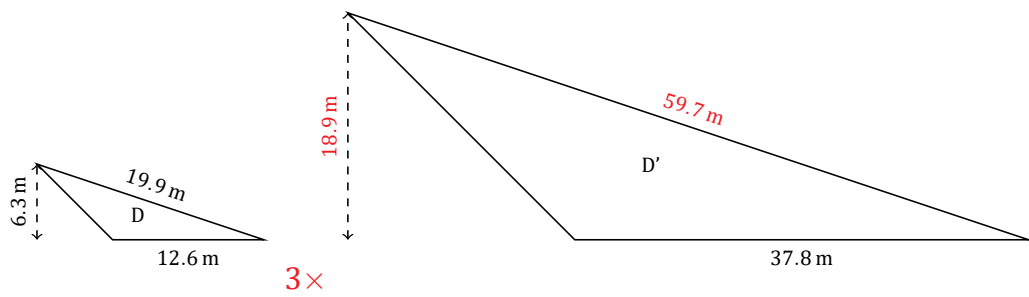
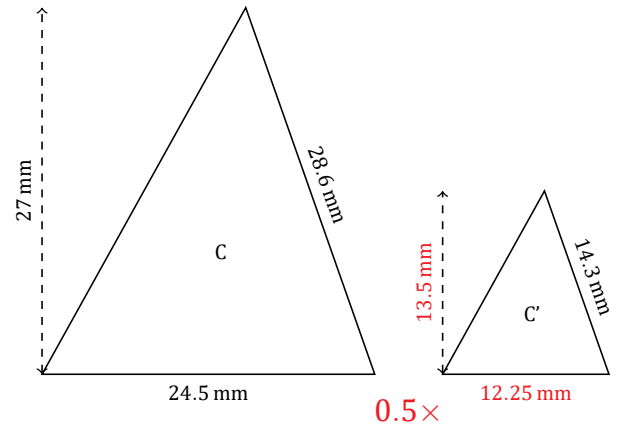
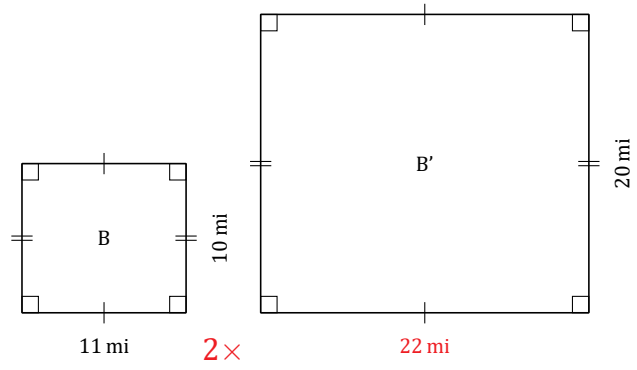
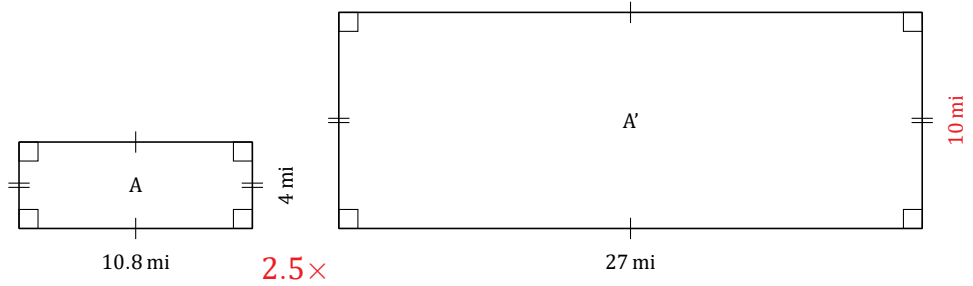



# Scale Factor (I)

Name: \_\_\_\_\_

Date: \_\_\_\_\_

Determine the scale factor for each pair of shapes and label the missing lengths.

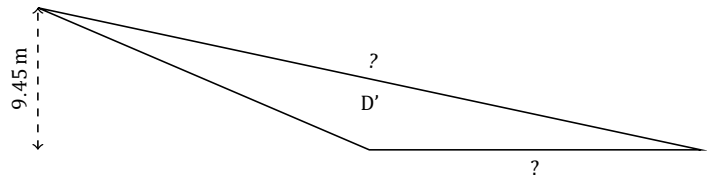
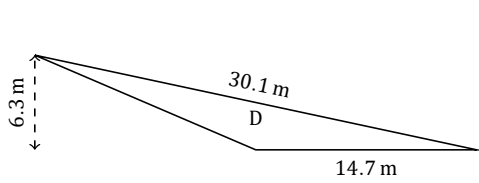
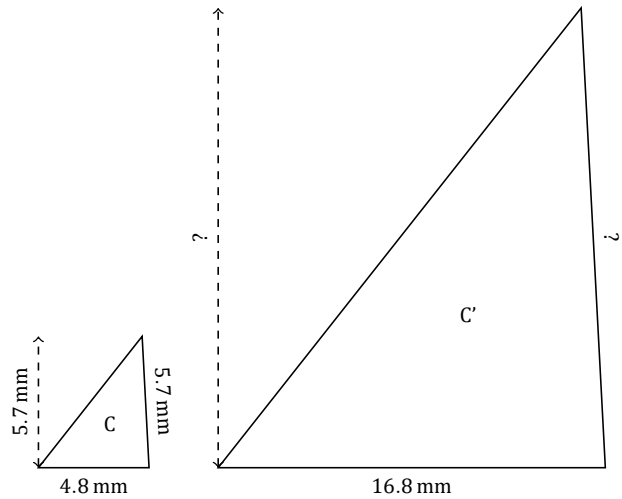
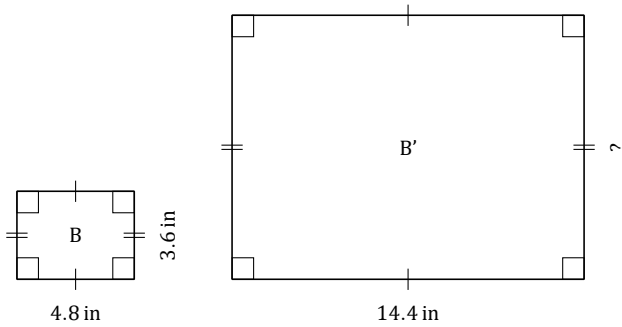
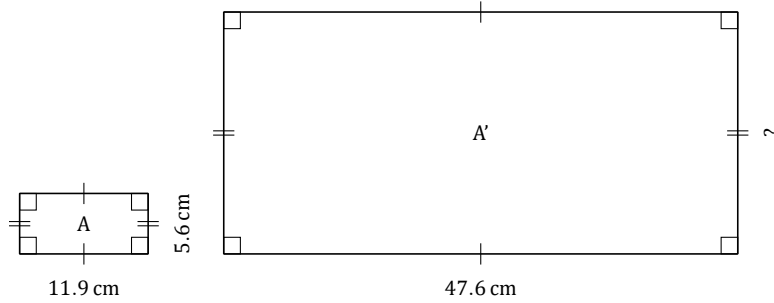

# Scale Factor (I) Answers

Name: \_\_\_\_\_

Date: \_\_\_\_\_

Determine the scale factor for each pair of shapes and label the missing lengths.

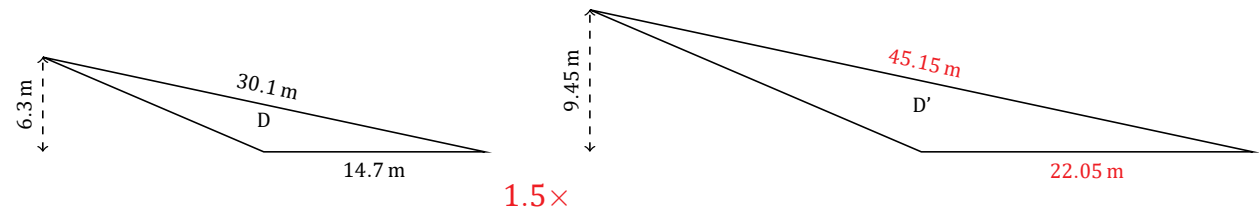
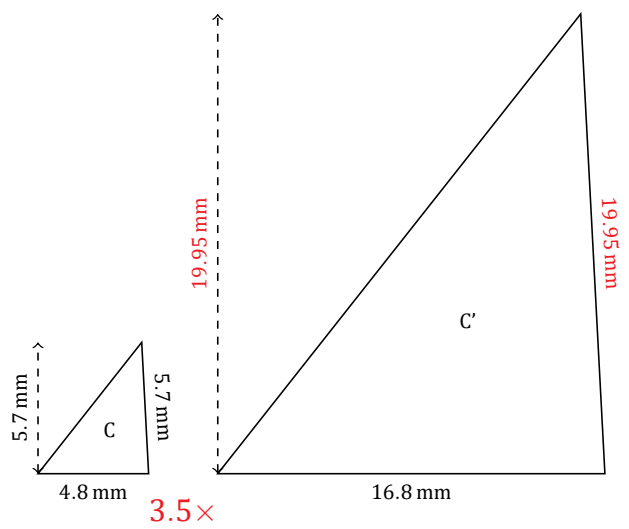
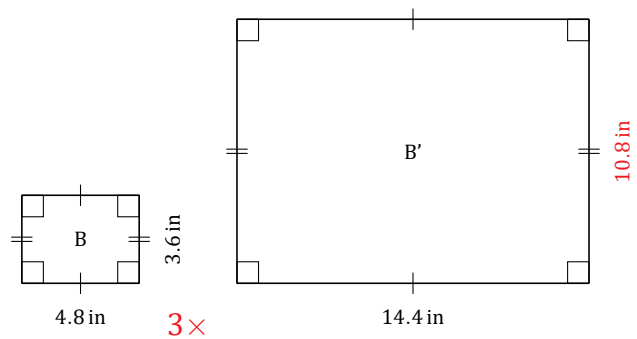
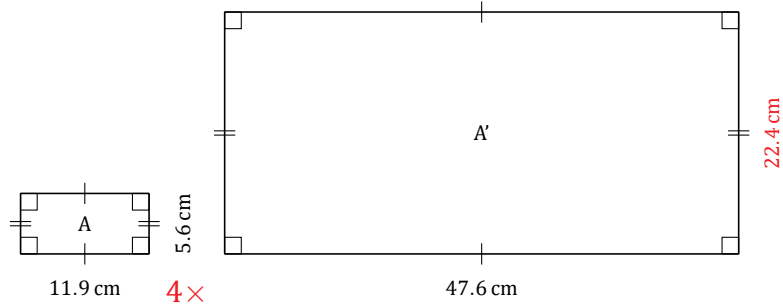

# Scale Factor (J)

Name: \_\_\_\_\_

Date: \_\_\_\_\_

Determine the scale factor for each pair of shapes and label the missing lengths.

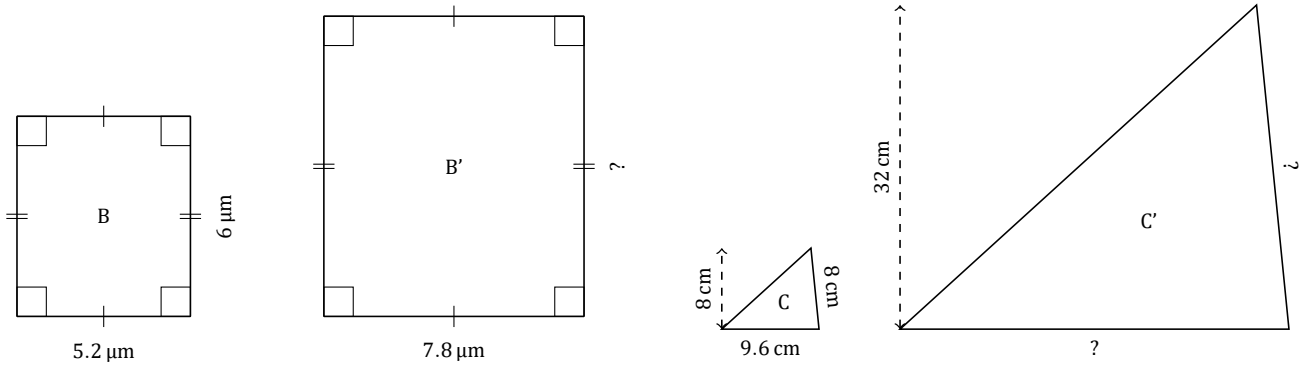
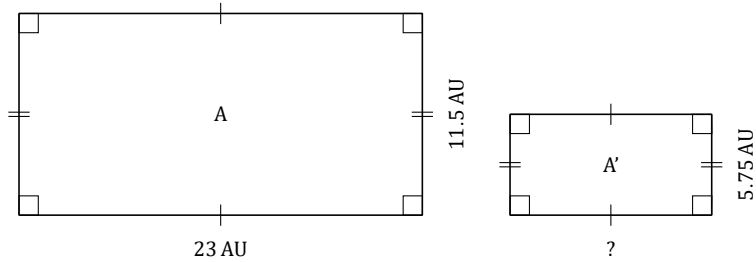

# Scale Factor (J) Answers

Name: \_\_\_\_\_

Date: \_\_\_\_\_

Determine the scale factor for each pair of shapes and label the missing lengths.

