

Rotations (A)

Draw the rotated image.

Rotate 90° clockwise about $(0, 0)$.

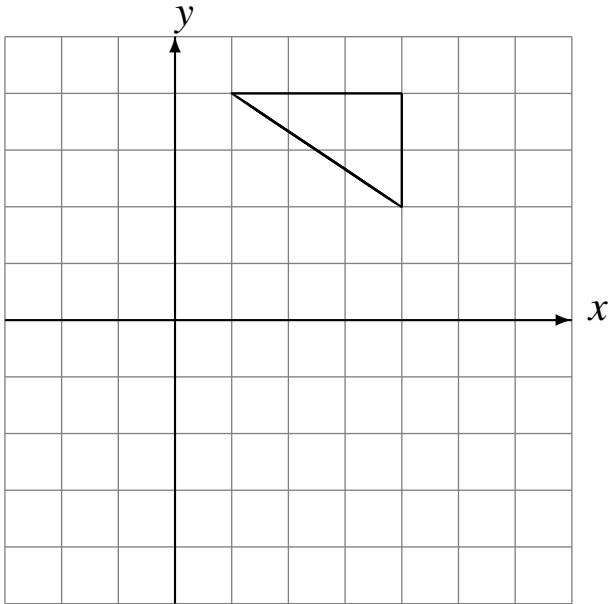

Rotate 90° clockwise about $(0, 0)$.

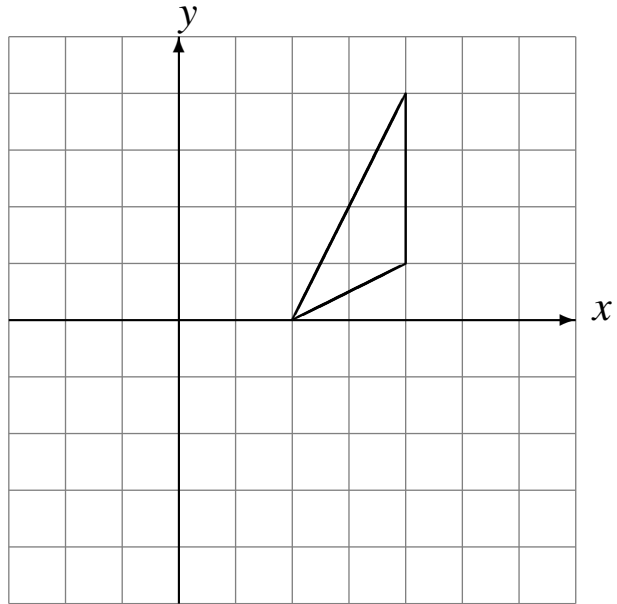

Rotate 90° clockwise about $(0, 0)$.

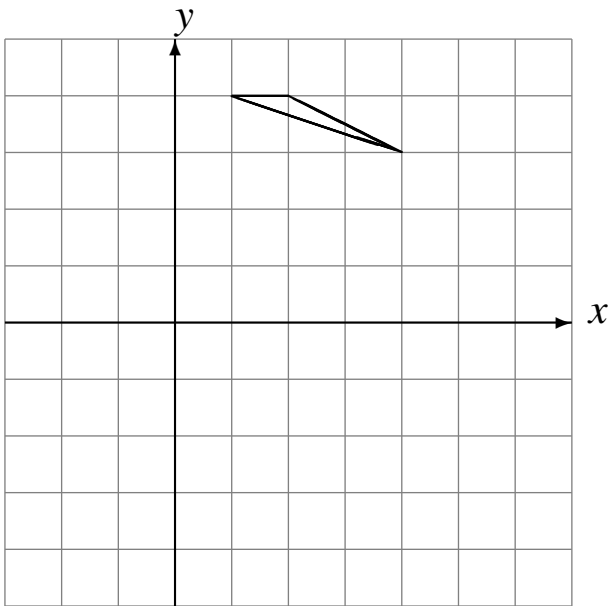

Rotate 90° counterclockwise about $(0, 0)$.

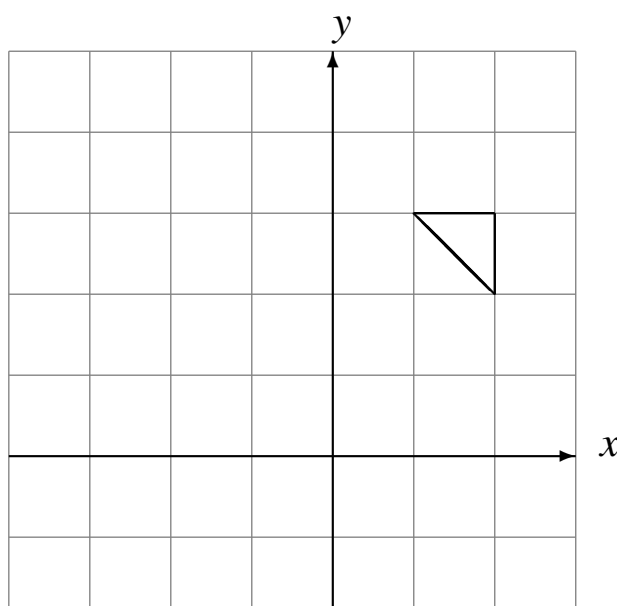

Rotations (A) Answers

Draw the rotated image.

Rotate 90° clockwise about $(0, 0)$.

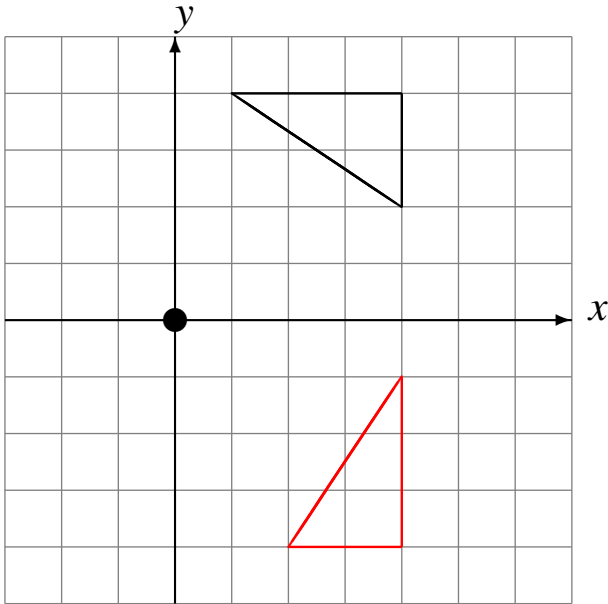

Rotate 90° clockwise about $(0, 0)$.

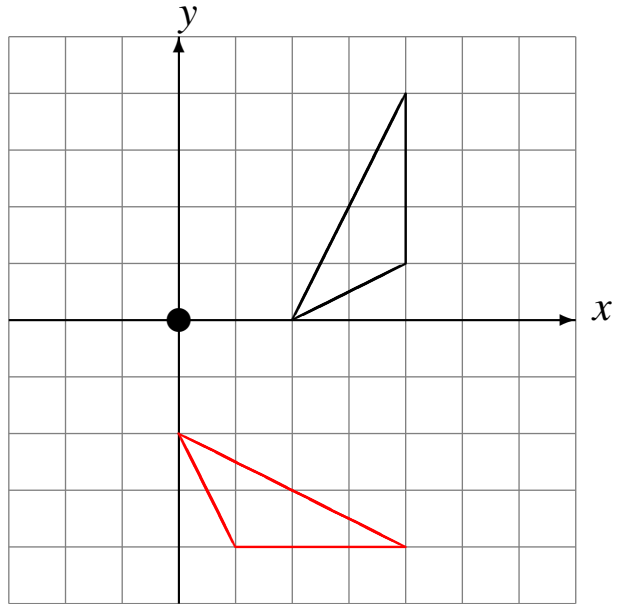

Rotate 90° clockwise about $(0, 0)$.

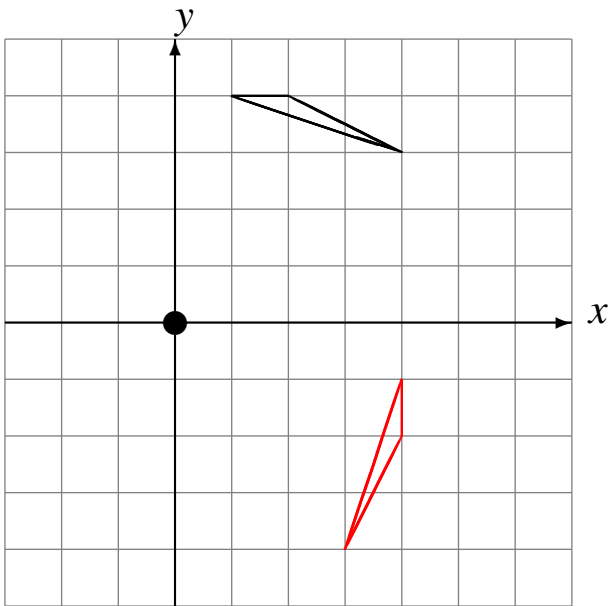

Rotate 90° counterclockwise about $(0, 0)$.

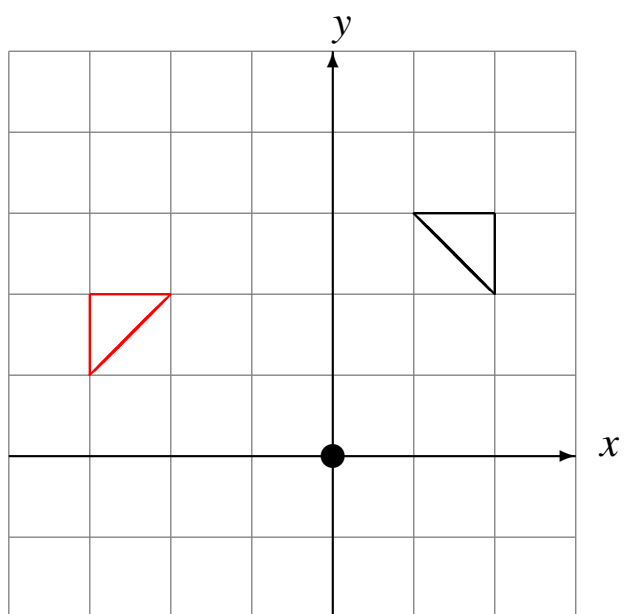

Rotations (B)

Draw the rotated image.

Rotate 180° about $(0, 0)$.

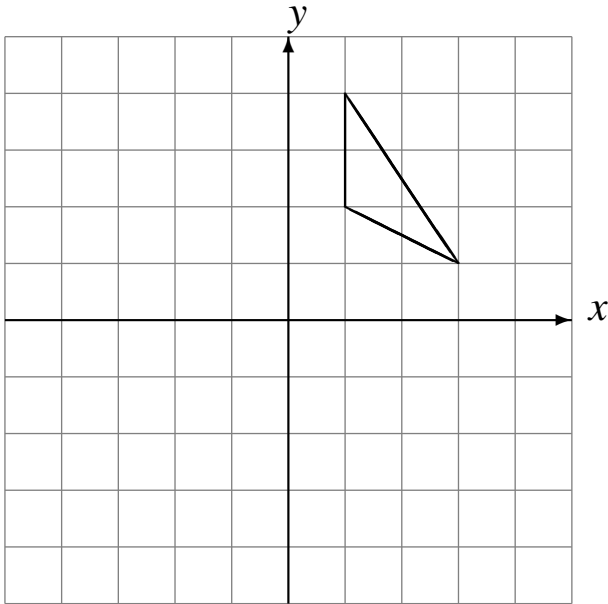

Rotate 180° about $(0, 0)$.

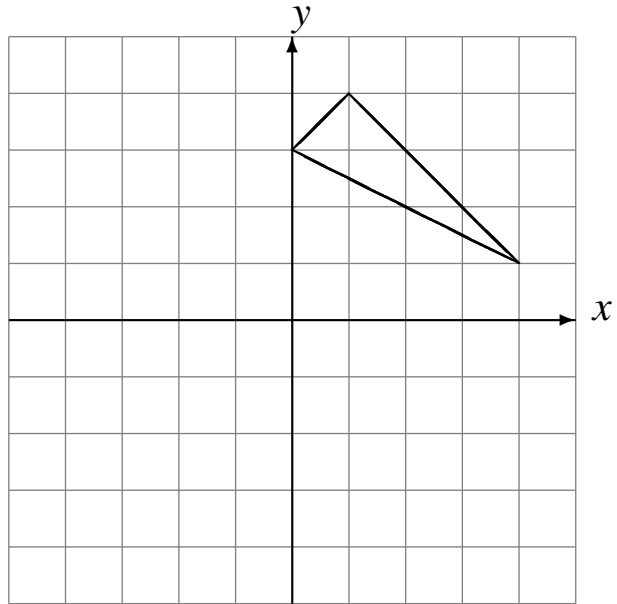

Rotate 90° counterclockwise about $(0, 0)$.

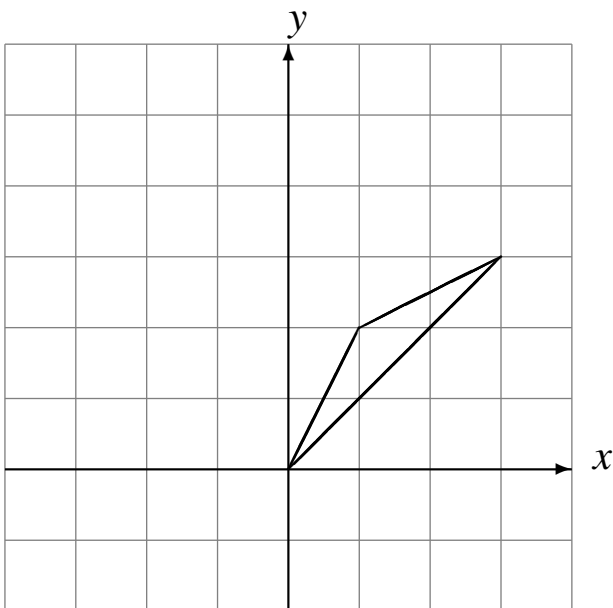

Rotate 180° about $(0, 0)$.

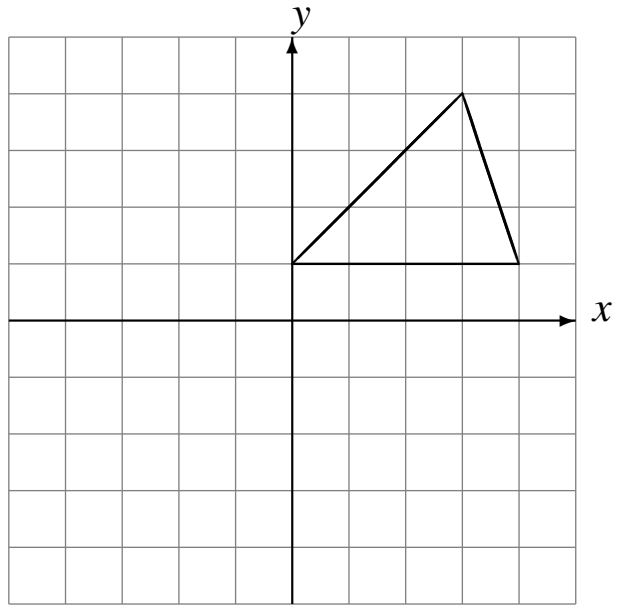

Rotations (B) Answers

Draw the rotated image.

Rotate 180° about $(0, 0)$.

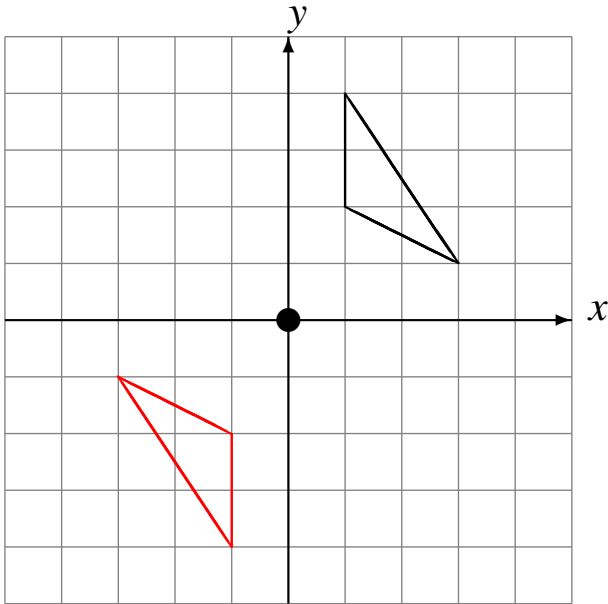

Rotate 180° about $(0, 0)$.

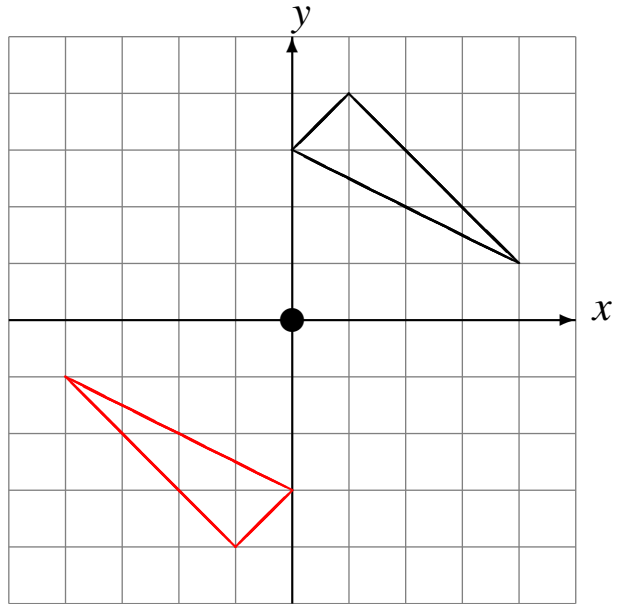

Rotate 90° counterclockwise about $(0, 0)$.

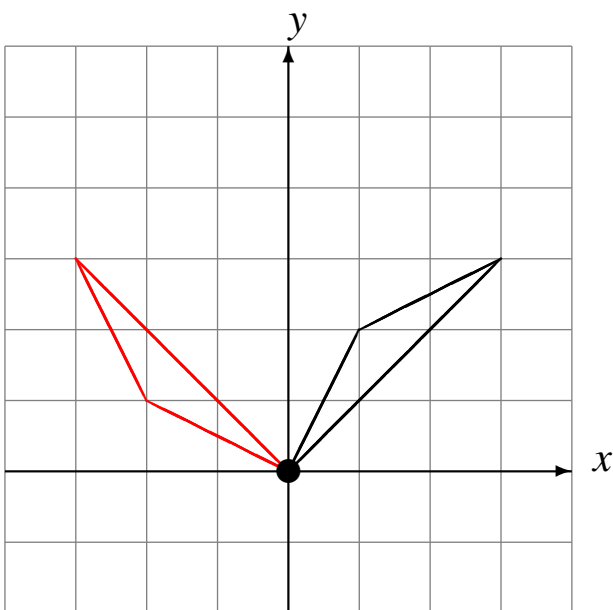

Rotate 180° about $(0, 0)$.

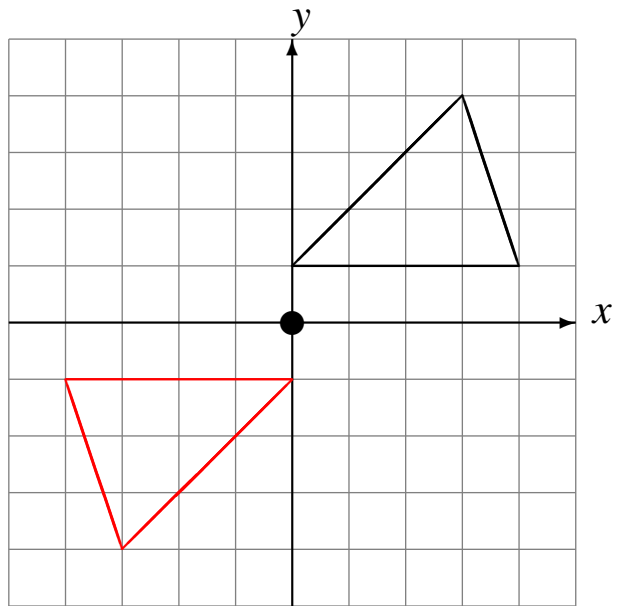

Rotations (C)

Draw the rotated image.

Rotate 90° counterclockwise about $(0, 0)$.

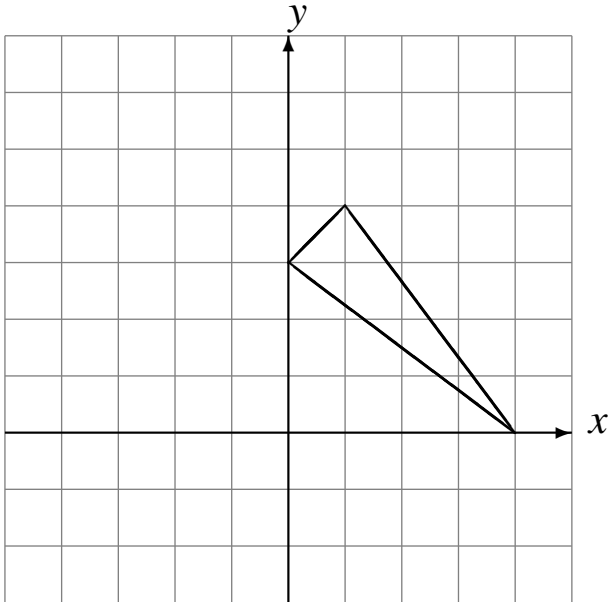

Rotate 90° clockwise about $(0, 0)$.

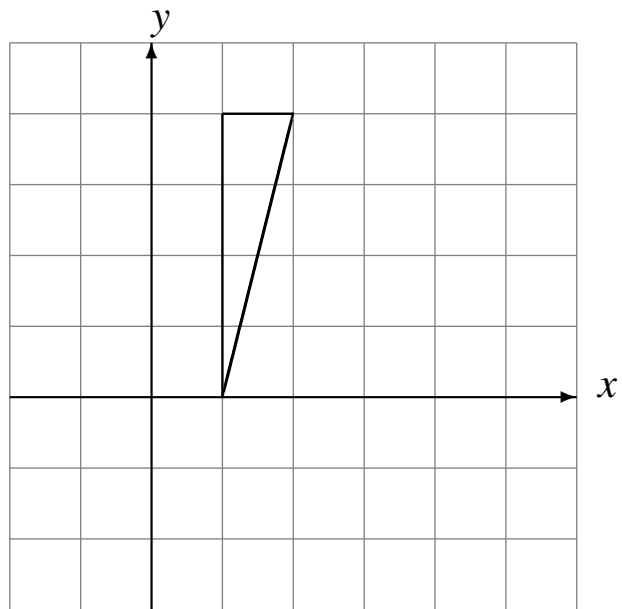

Rotate 90° counterclockwise about $(0, 0)$.

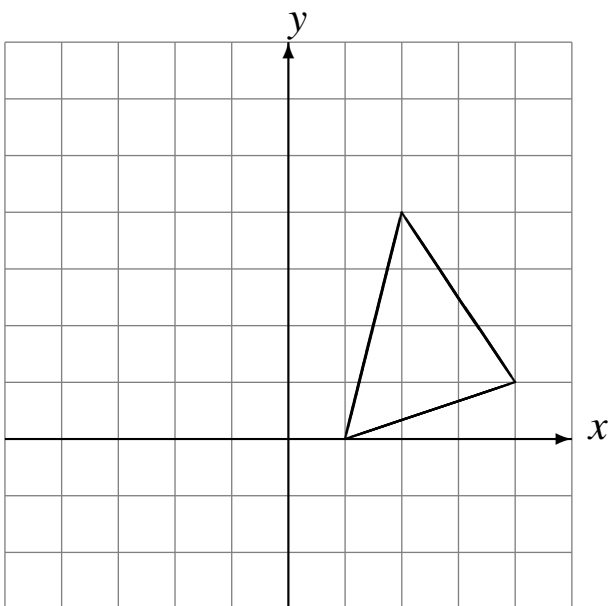

Rotate 90° counterclockwise about $(0, 0)$.

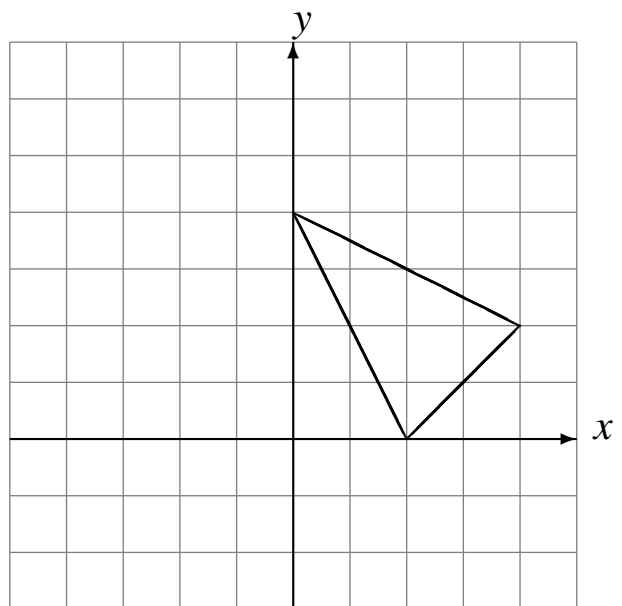

Rotations (C) Answers

Draw the rotated image.

Rotate 90° counterclockwise about $(0, 0)$.

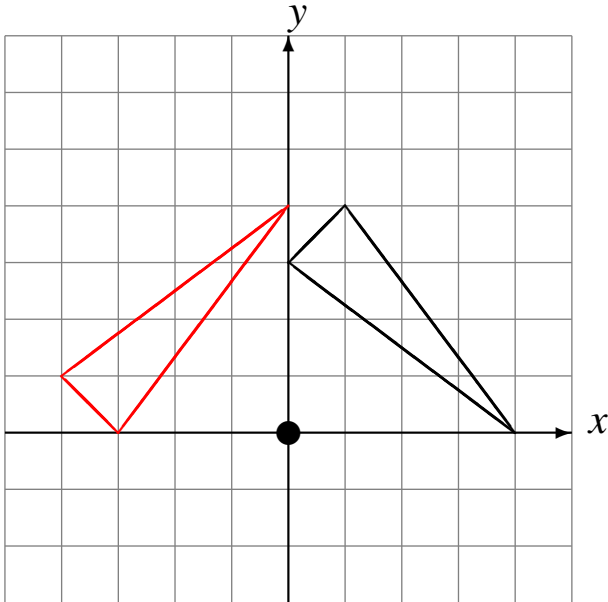

Rotate 90° clockwise about $(0, 0)$.

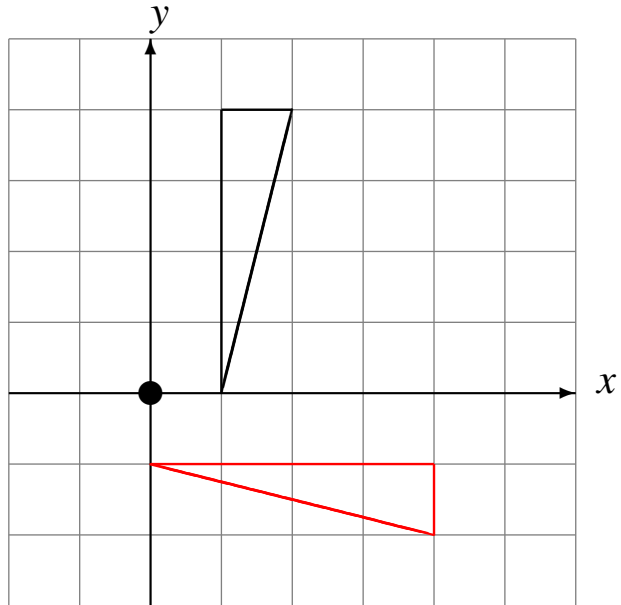

Rotate 90° counterclockwise about $(0, 0)$.

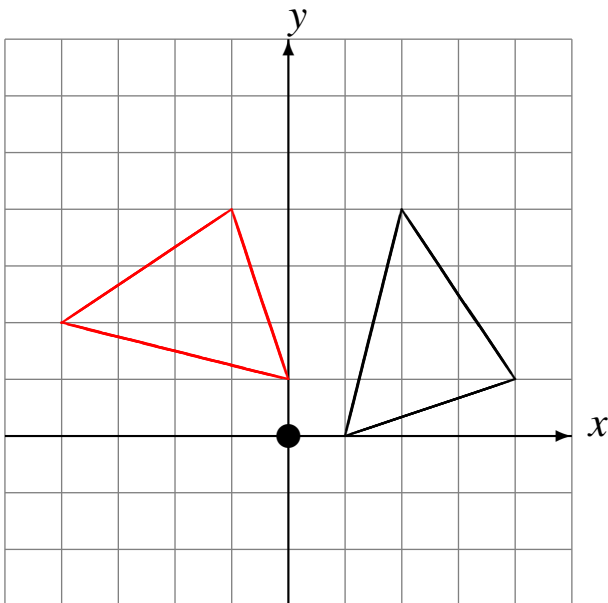

Rotate 90° counterclockwise about $(0, 0)$.

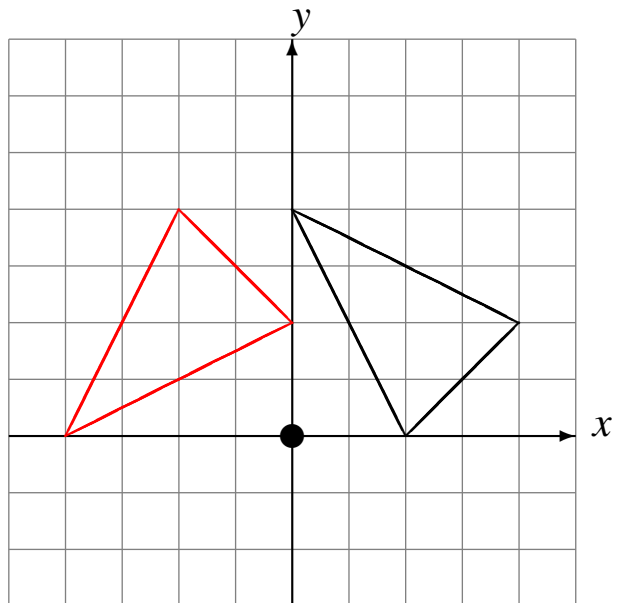

Rotations (D)

Draw the rotated image.

Rotate 180° about $(0, 0)$.

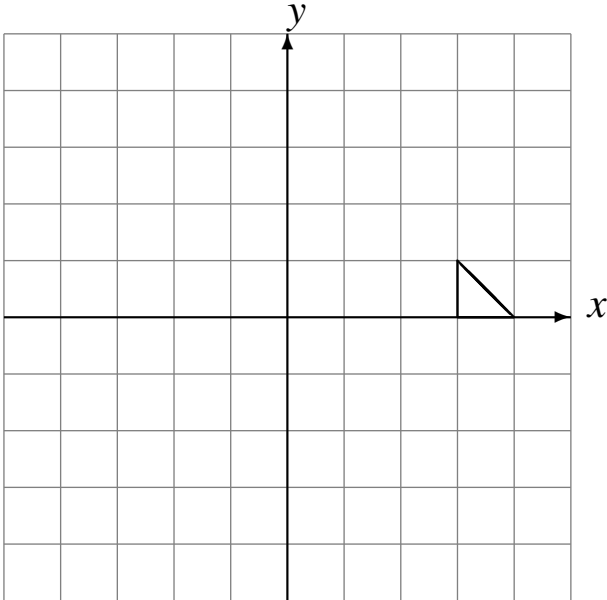

Rotate 90° clockwise about $(0, 0)$.

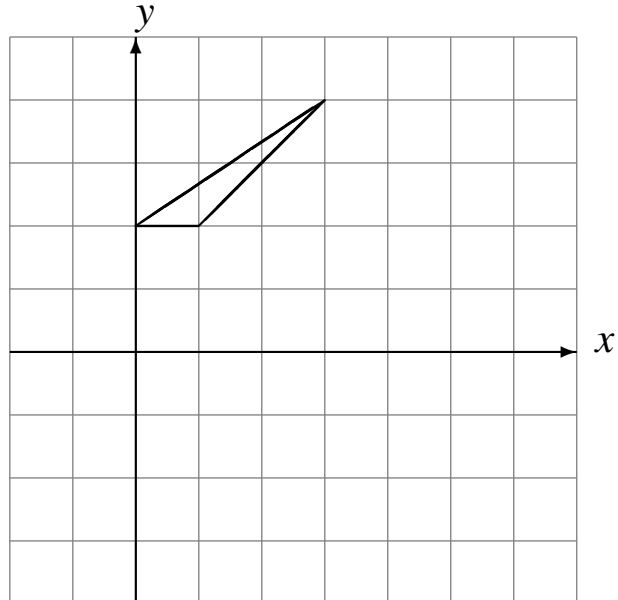

Rotate 90° counterclockwise about $(0, 0)$.

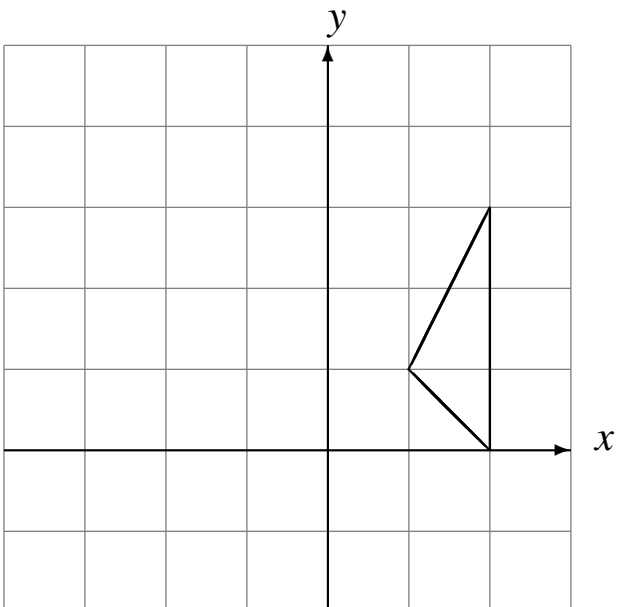

Rotate 90° clockwise about $(0, 0)$.

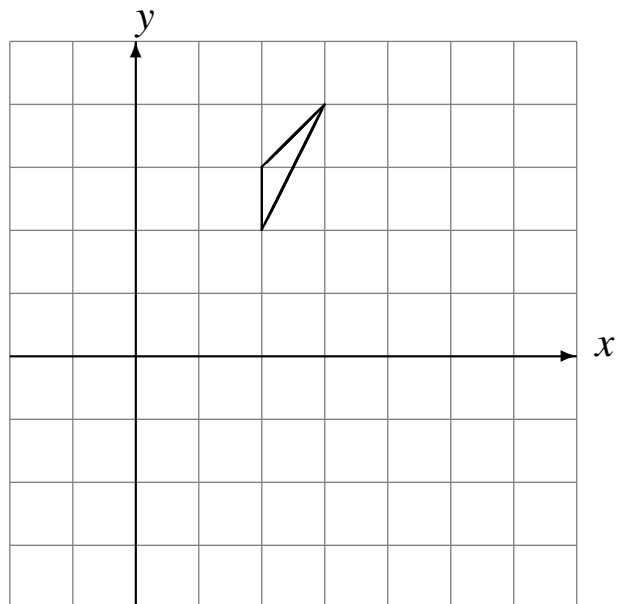

Rotations (D) Answers

Draw the rotated image.

Rotate 180° about $(0, 0)$.

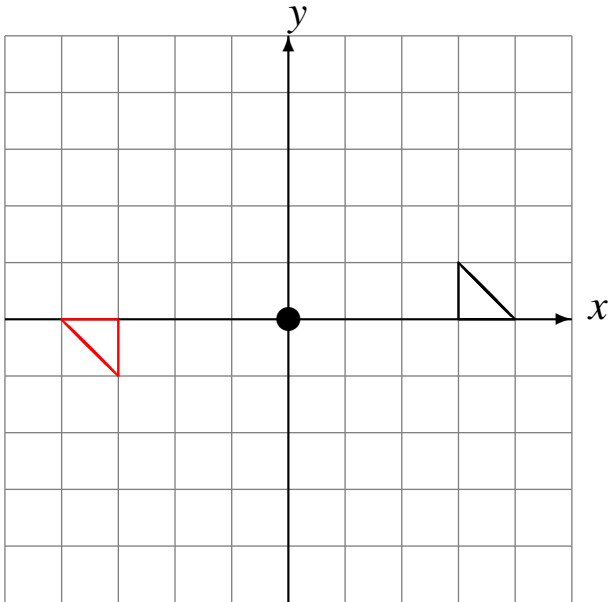

Rotate 90° clockwise about $(0, 0)$.

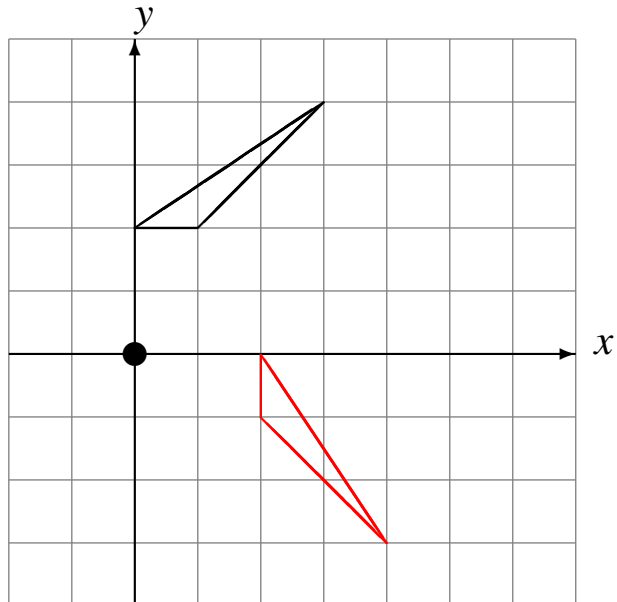

Rotate 90° counterclockwise about $(0, 0)$.

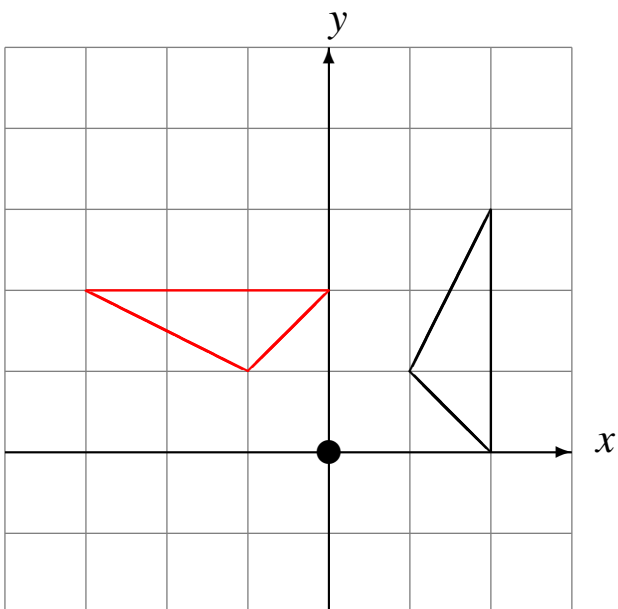

Rotate 90° clockwise about $(0, 0)$.

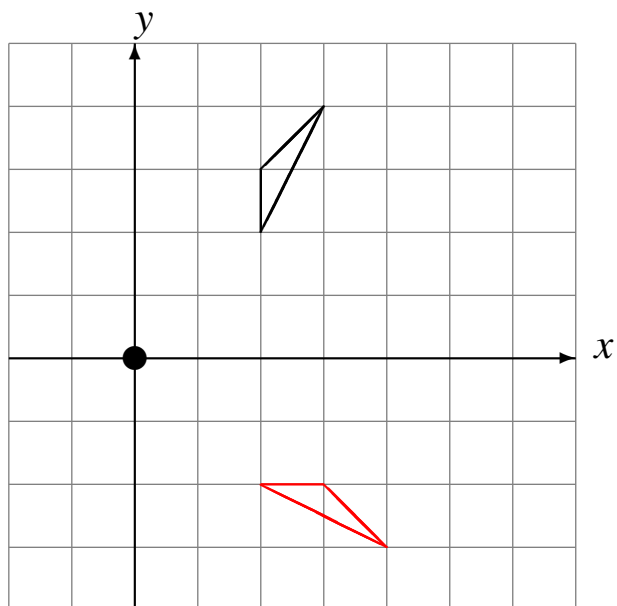

Rotations (E)

Draw the rotated image.

Rotate 90° clockwise about $(0, 0)$.

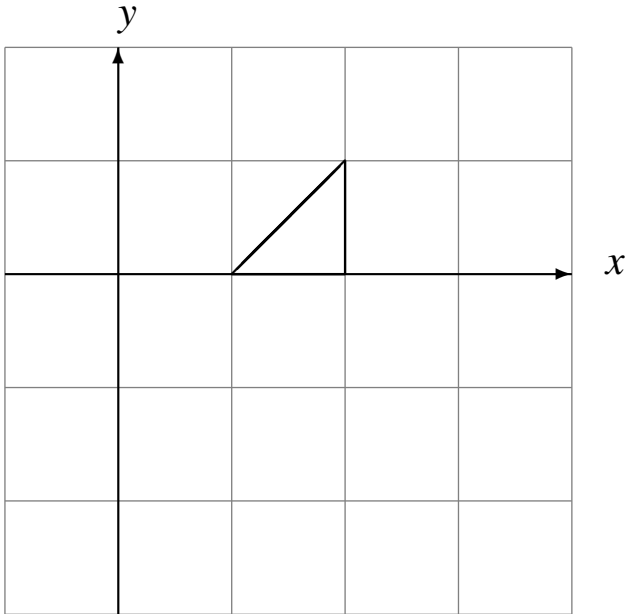

Rotate 180° about $(0, 0)$.

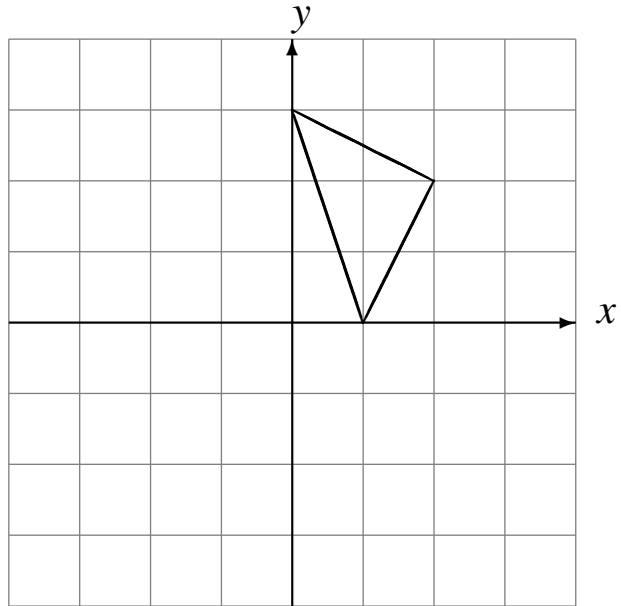

Rotate 180° about $(0, 0)$.

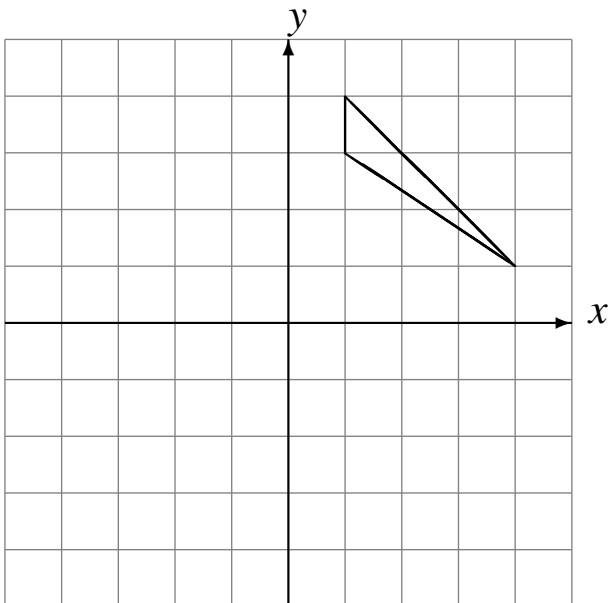

Rotate 90° clockwise about $(0, 0)$.

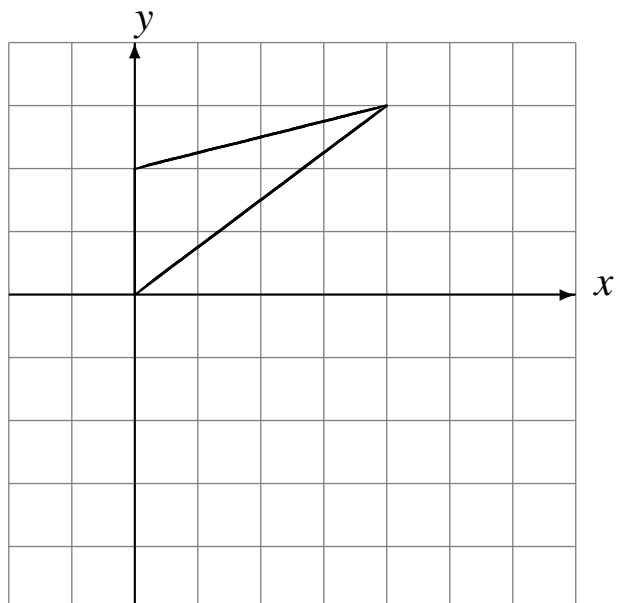

Rotations (E) Answers

Draw the rotated image.

Rotate 90° clockwise about $(0, 0)$.

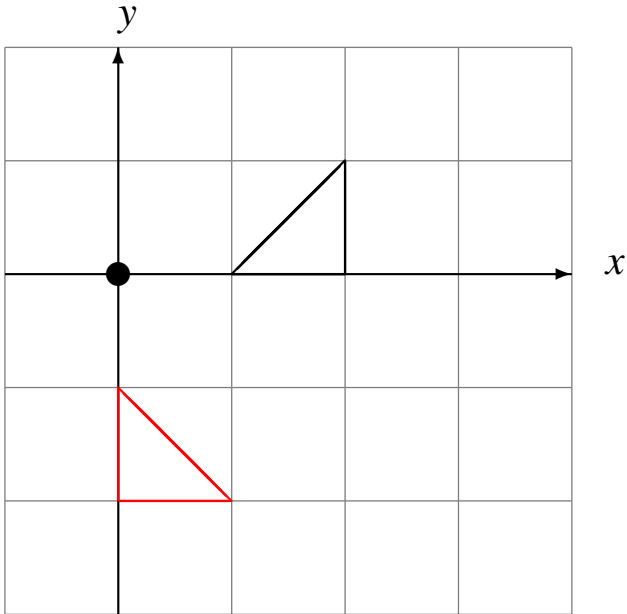

Rotate 180° about $(0, 0)$.

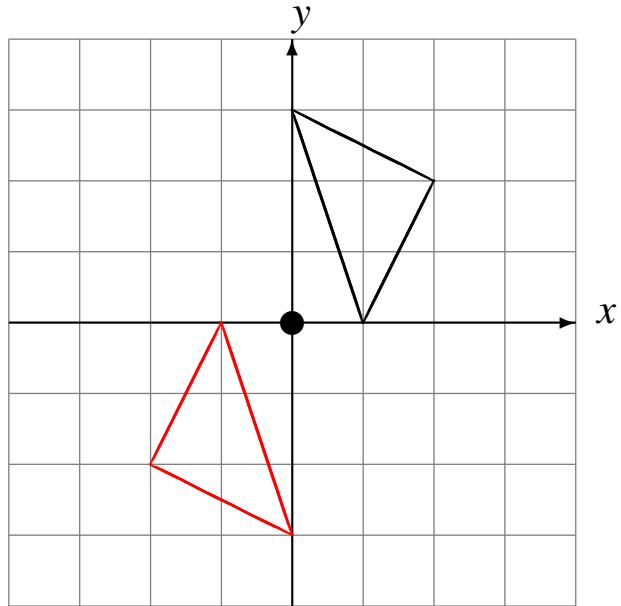

Rotate 180° about $(0, 0)$.

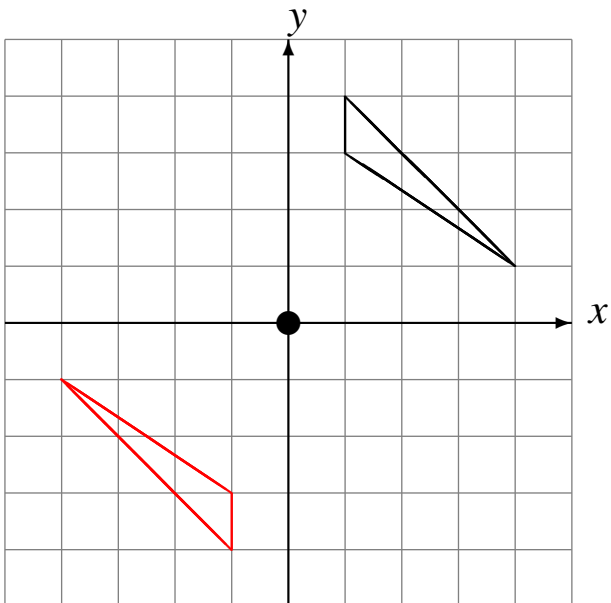

Rotate 90° clockwise about $(0, 0)$.

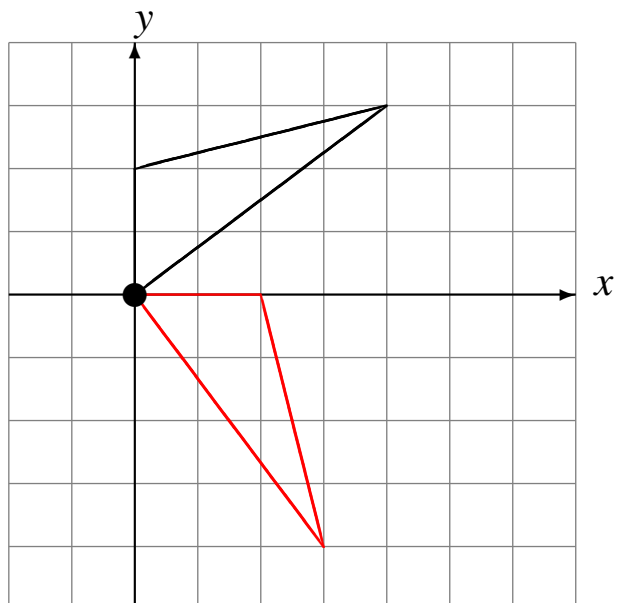

Rotations (F)

Draw the rotated image.

Rotate 180° about $(0, 0)$.

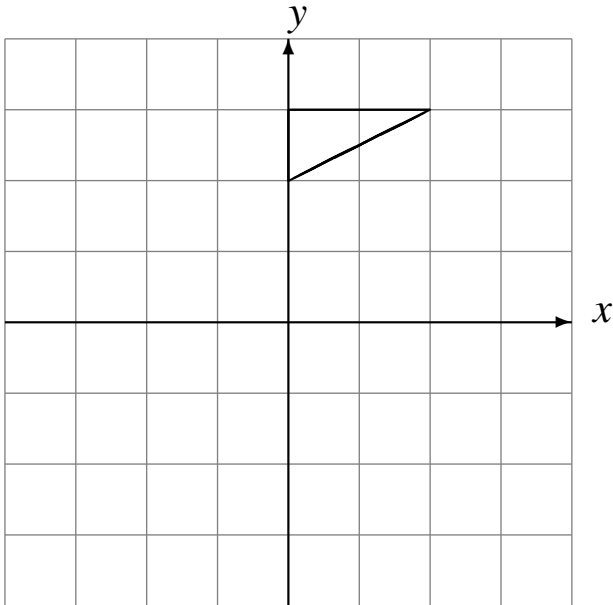

Rotate 180° about $(0, 0)$.

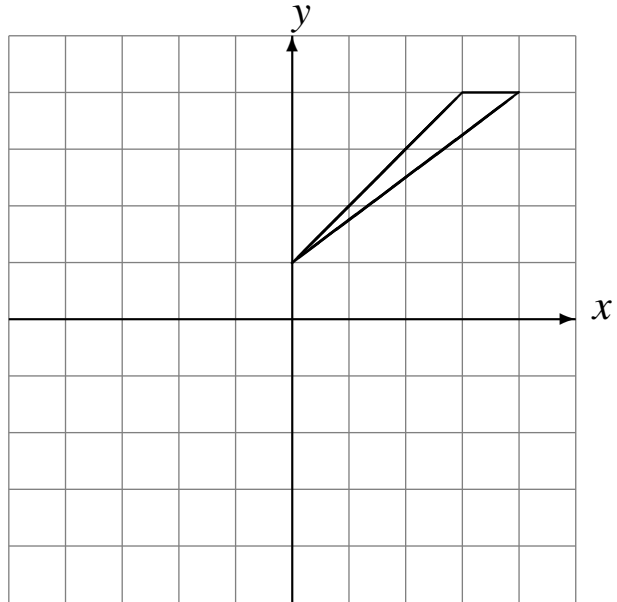

Rotate 180° about $(0, 0)$.

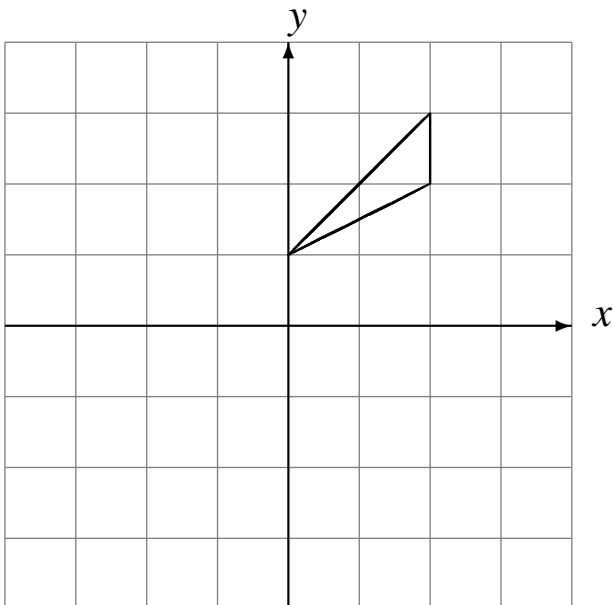

Rotate 180° about $(0, 0)$.

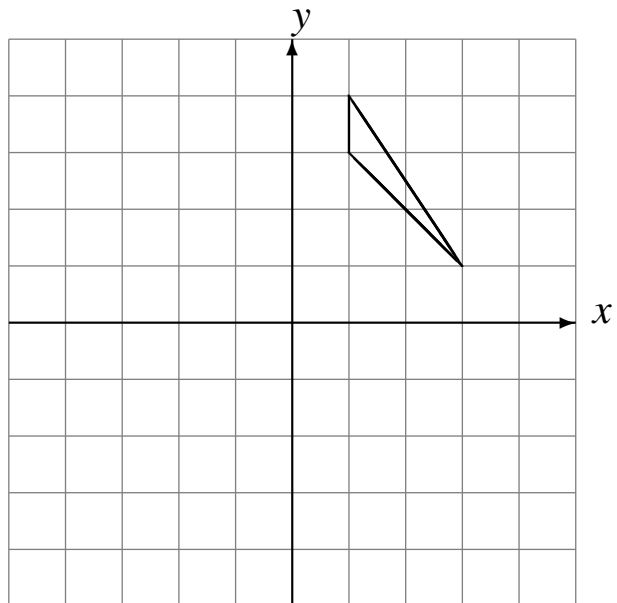

Rotations (F) Answers

Draw the rotated image.

Rotate 180° about $(0, 0)$.

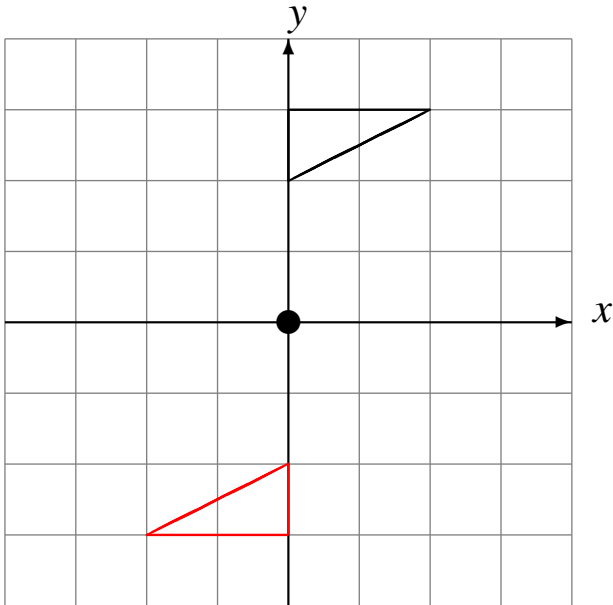

Rotate 180° about $(0, 0)$.

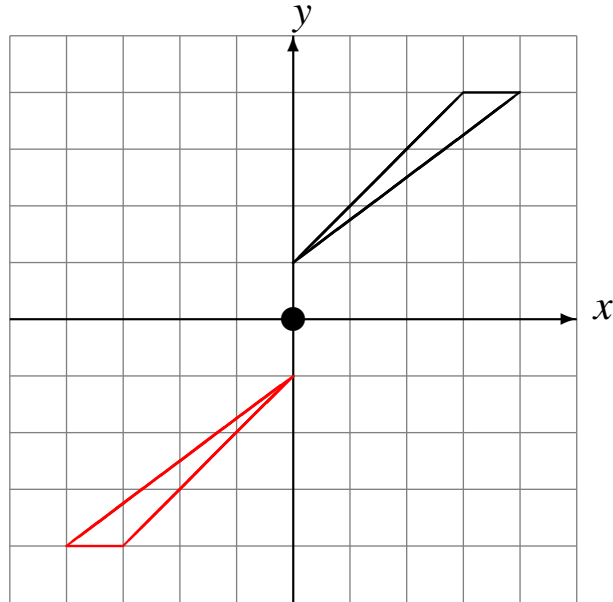

Rotate 180° about $(0, 0)$.

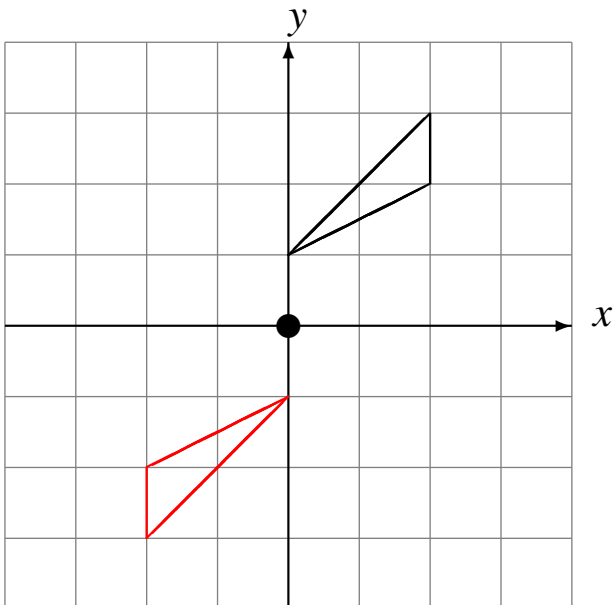

Rotate 180° about $(0, 0)$.

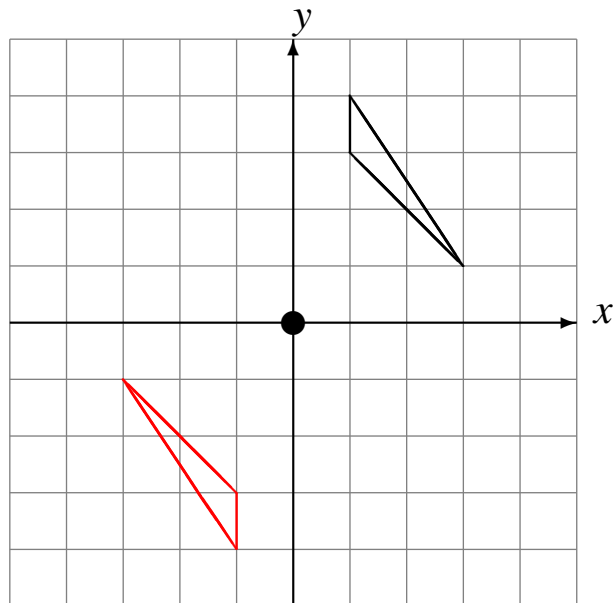

Rotations (G)

Draw the rotated image.

Rotate 90° clockwise about $(0, 0)$.

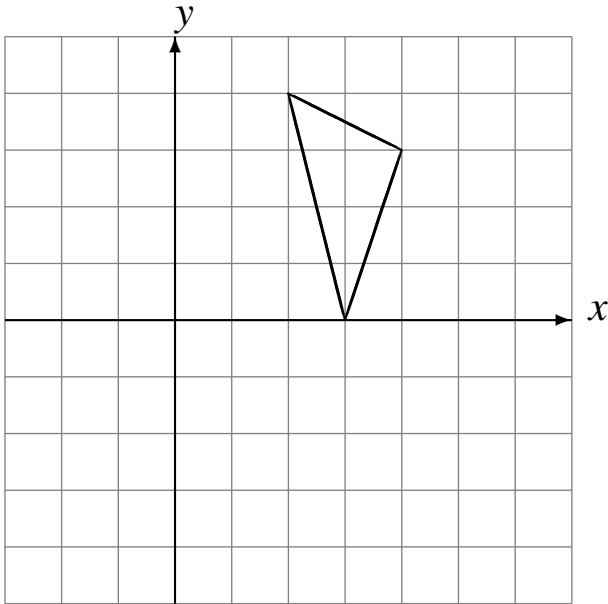

Rotate 90° clockwise about $(0, 0)$.

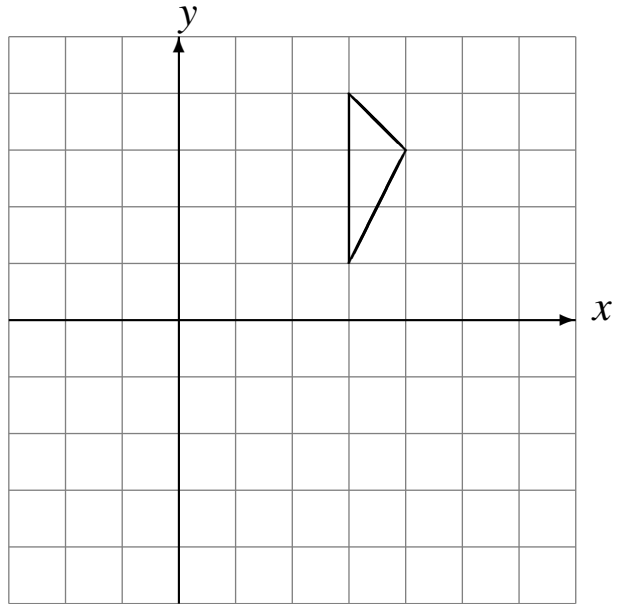

Rotate 90° clockwise about $(0, 0)$.

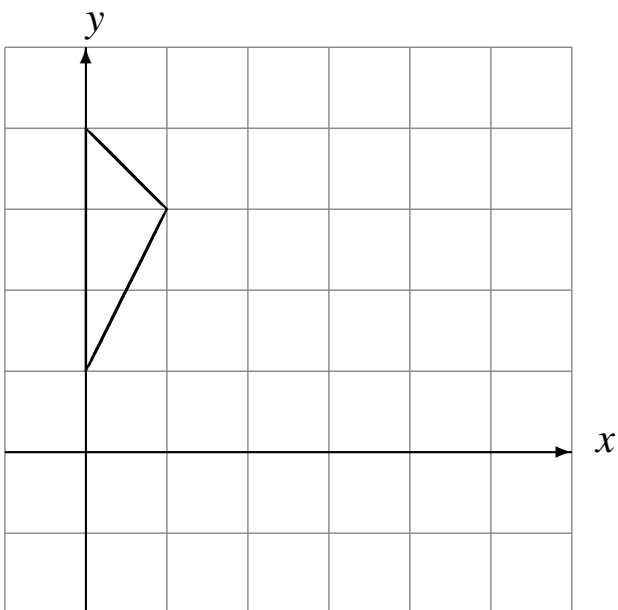

Rotate 90° counterclockwise about $(0, 0)$.

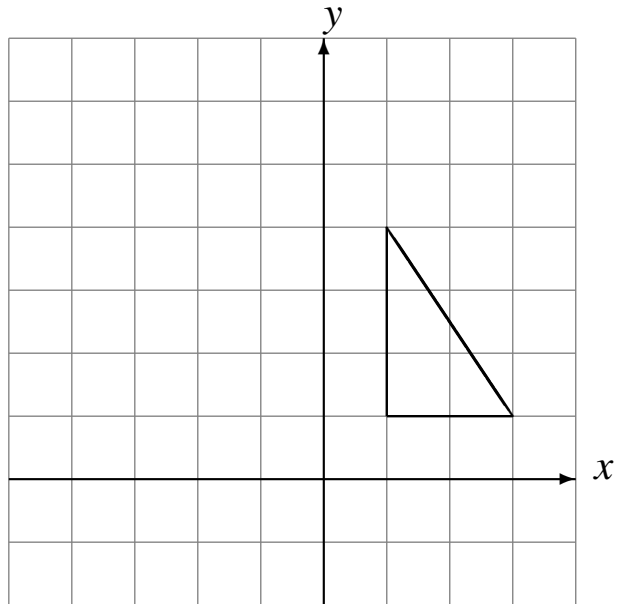

Rotations (G) Answers

Draw the rotated image.

Rotate 90° clockwise about $(0, 0)$.

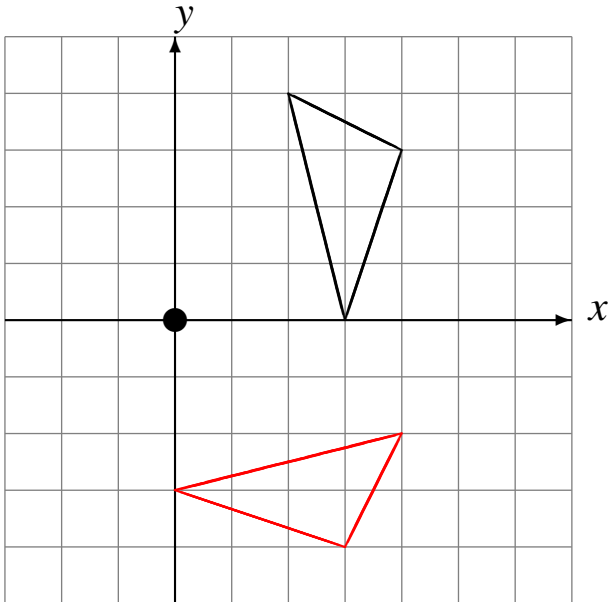

Rotate 90° clockwise about $(0, 0)$.

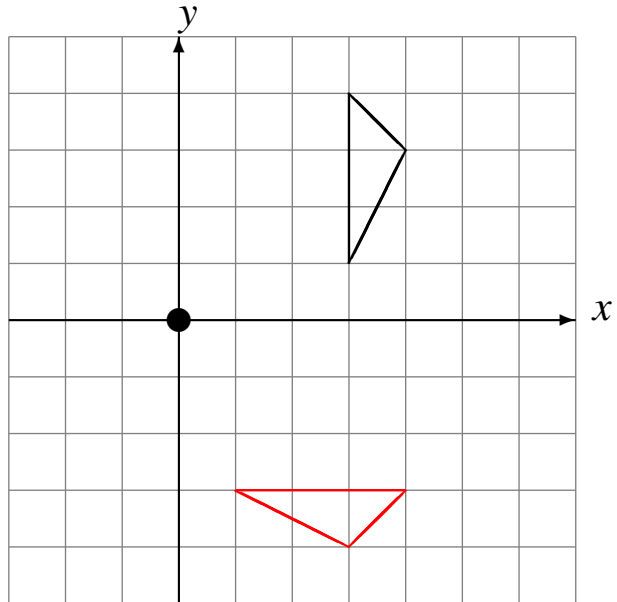

Rotate 90° clockwise about $(0, 0)$.

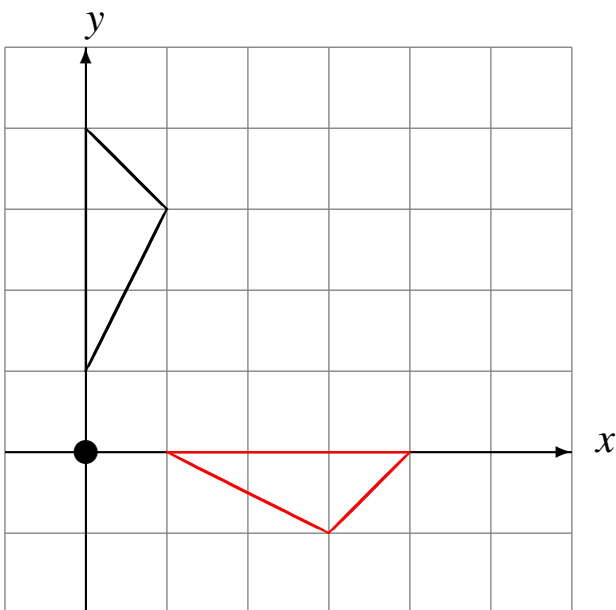

Rotate 90° counterclockwise about $(0, 0)$.

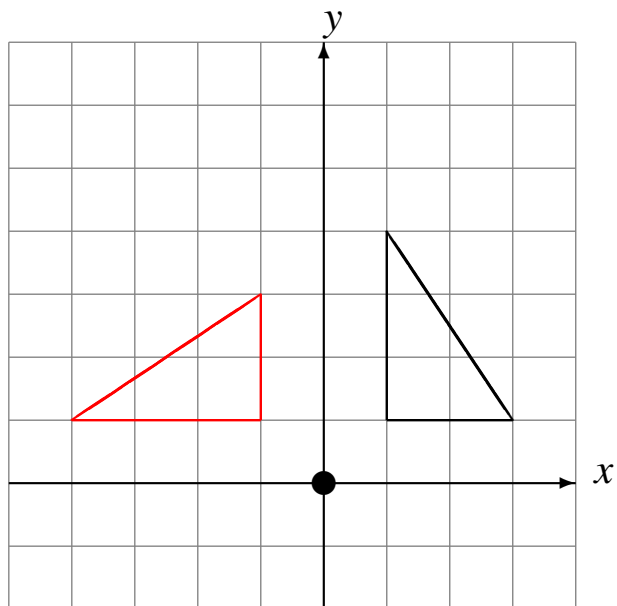

Rotations (H)

Draw the rotated image.

Rotate 180° about $(0, 0)$.

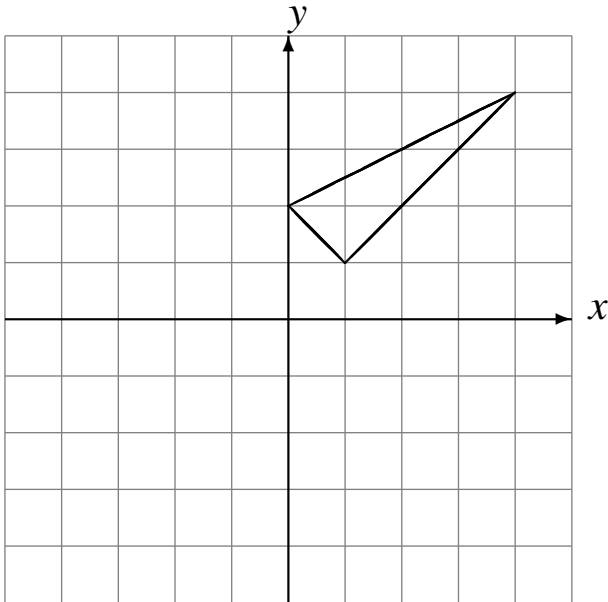

Rotate 90° counterclockwise about $(0, 0)$.

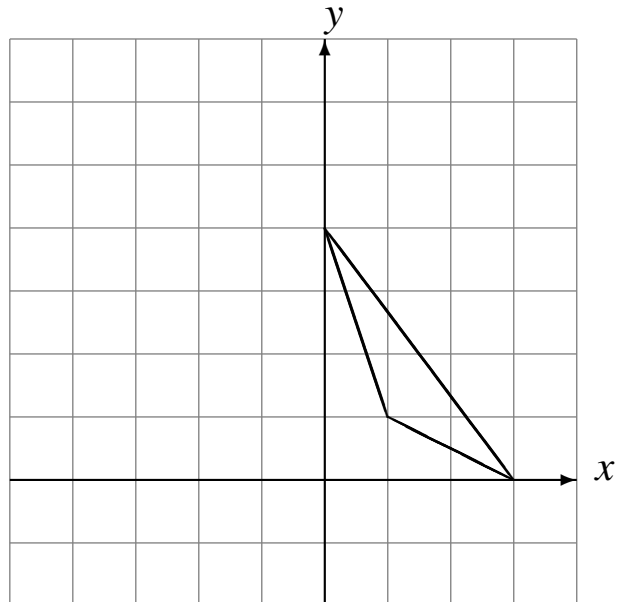

Rotate 180° about $(0, 0)$.

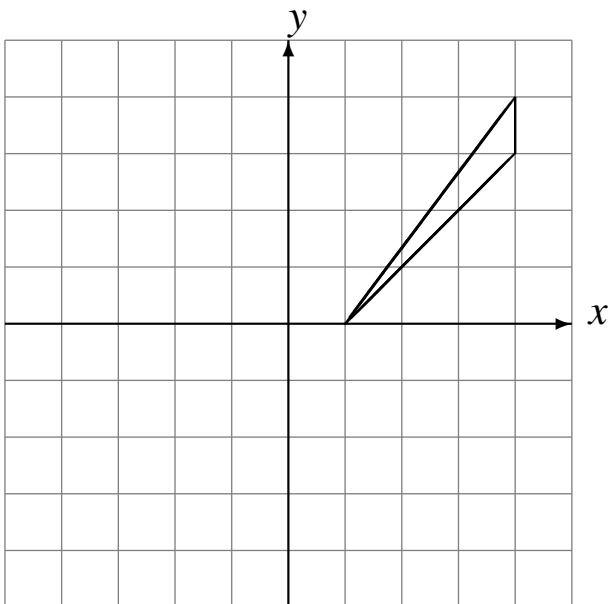

Rotate 180° about $(0, 0)$.

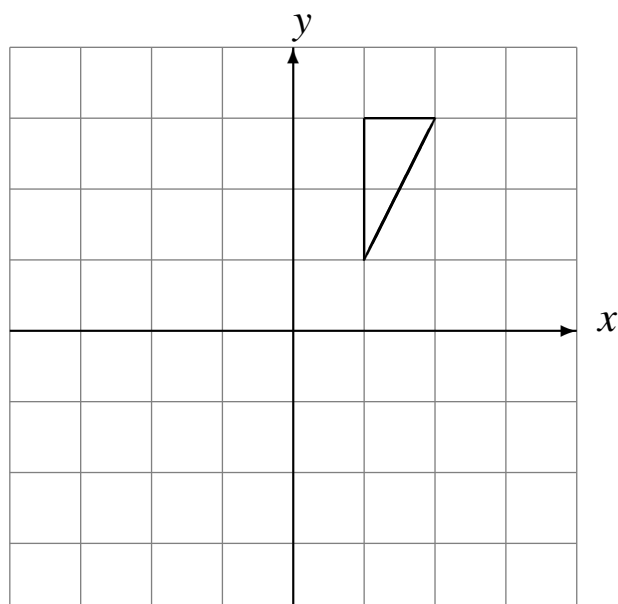

Rotations (H) Answers

Draw the rotated image.

Rotate 180° about $(0, 0)$.

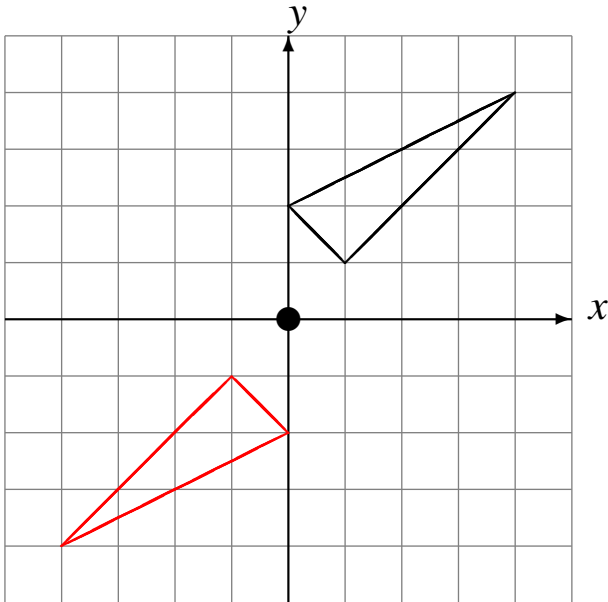

Rotate 90° counterclockwise about $(0, 0)$.

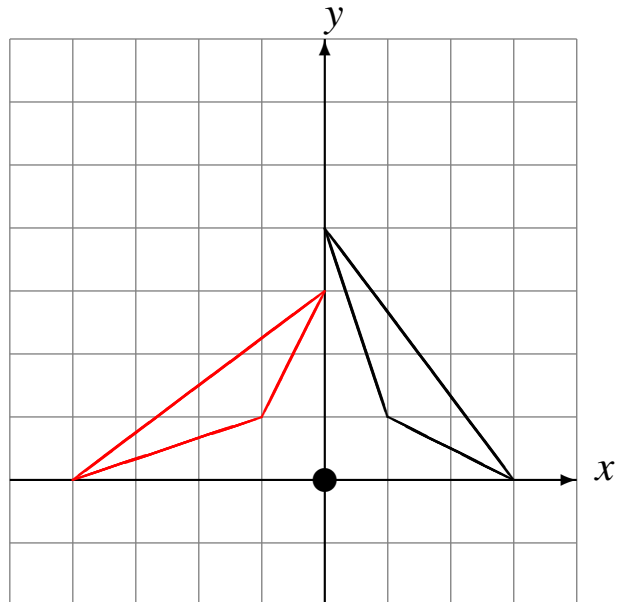

Rotate 180° about $(0, 0)$.

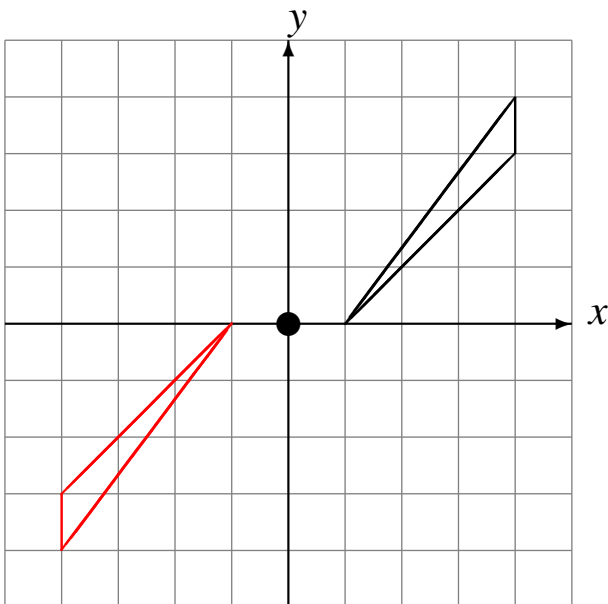

Rotate 180° about $(0, 0)$.

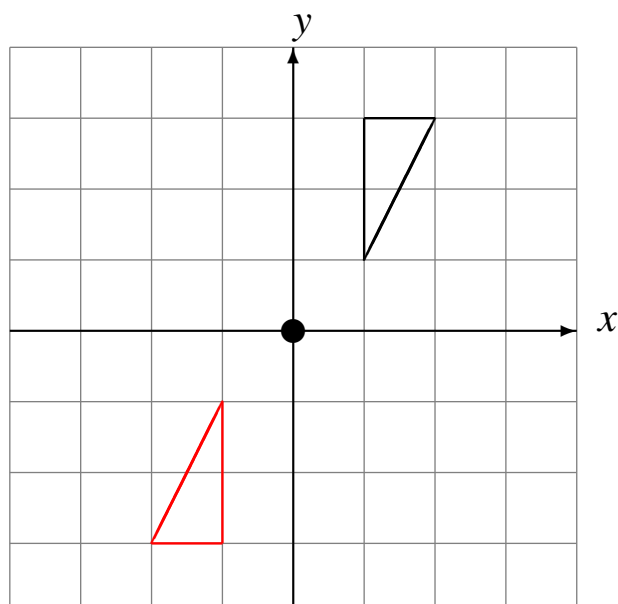

Rotations (I)

Draw the rotated image.

Rotate 180° about $(0, 0)$.

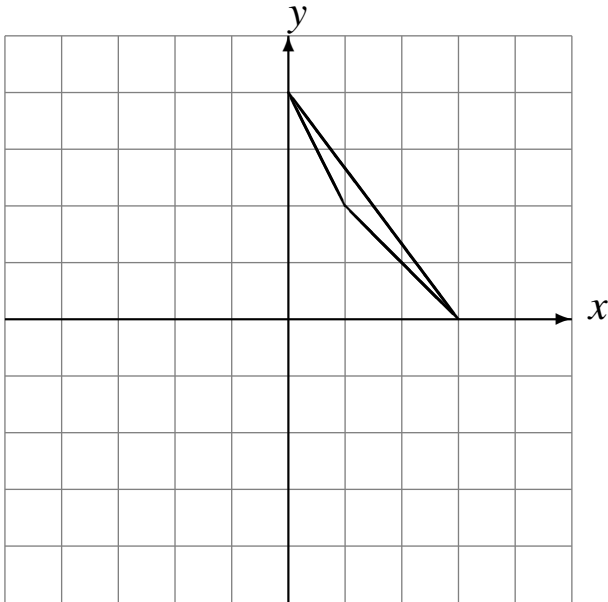

Rotate 90° counterclockwise about $(0, 0)$.

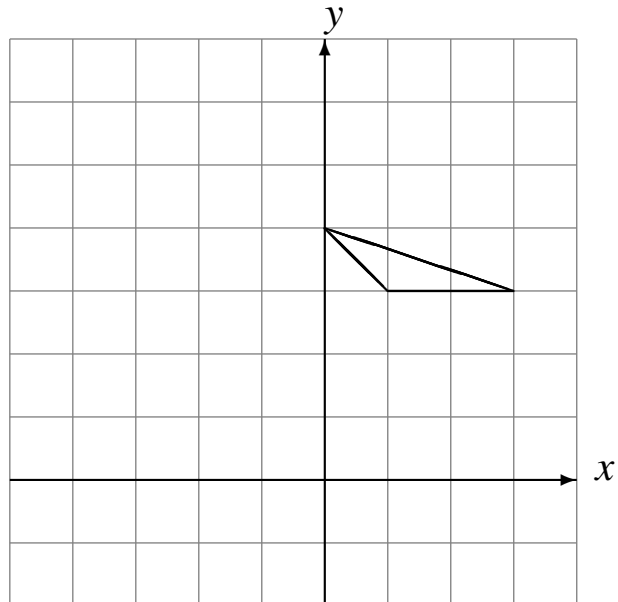

Rotate 90° counterclockwise about $(0, 0)$.

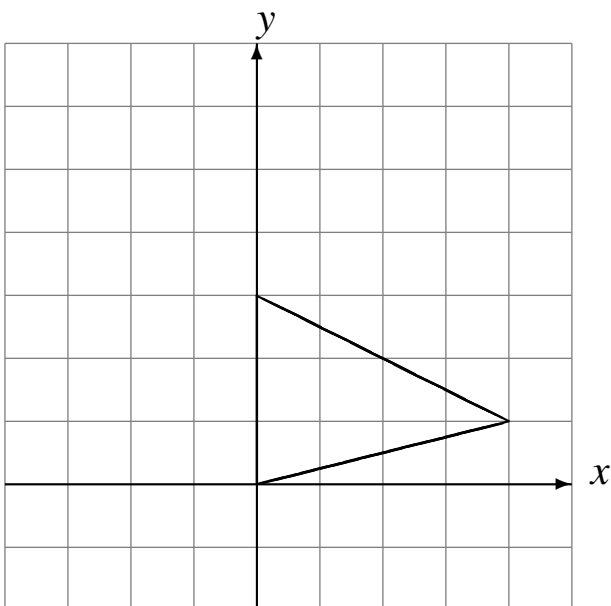

Rotate 90° counterclockwise about $(0, 0)$.

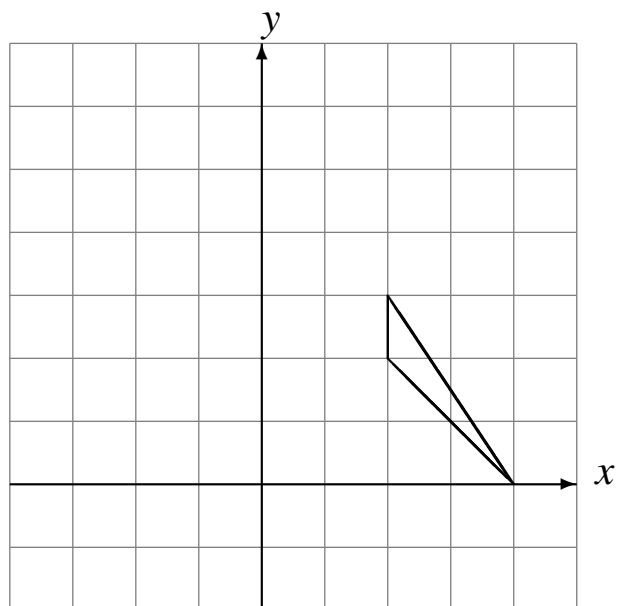

Rotations (I) Answers

Draw the rotated image.

Rotate 180° about $(0, 0)$.

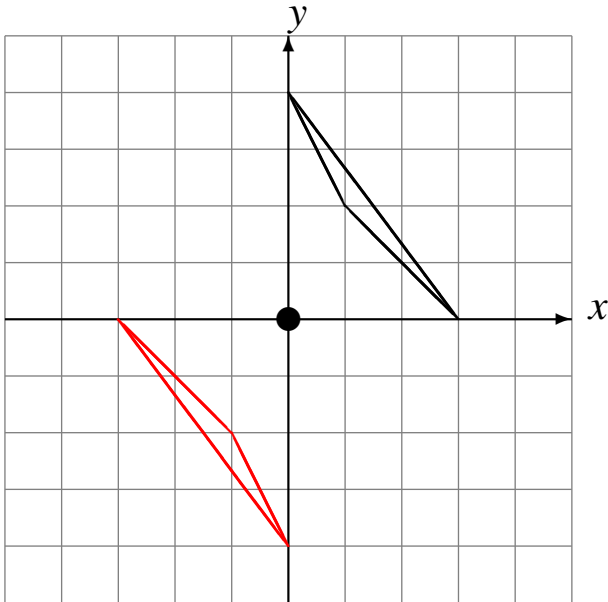

Rotate 90° counterclockwise about $(0, 0)$.

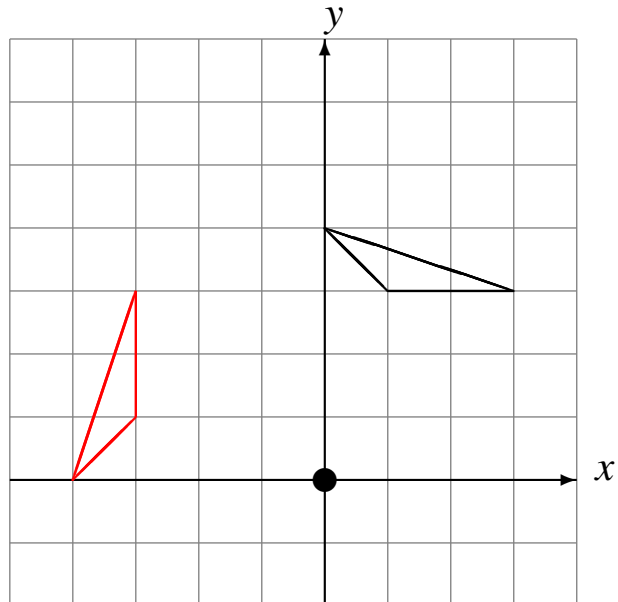

Rotate 90° counterclockwise about $(0, 0)$.

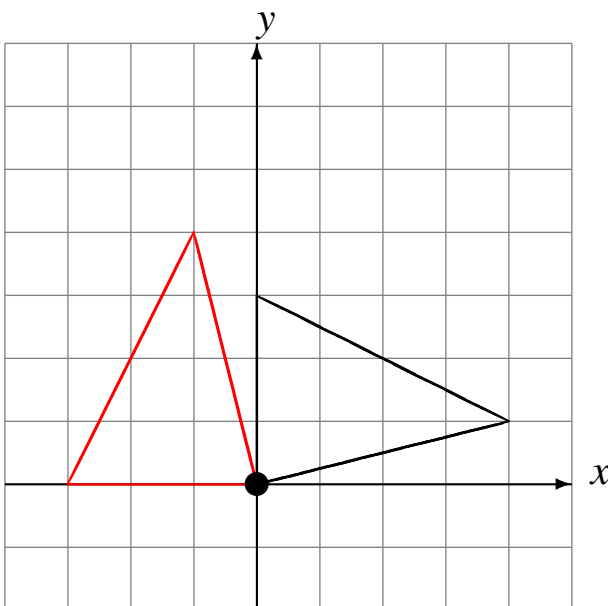

Rotate 90° counterclockwise about $(0, 0)$.

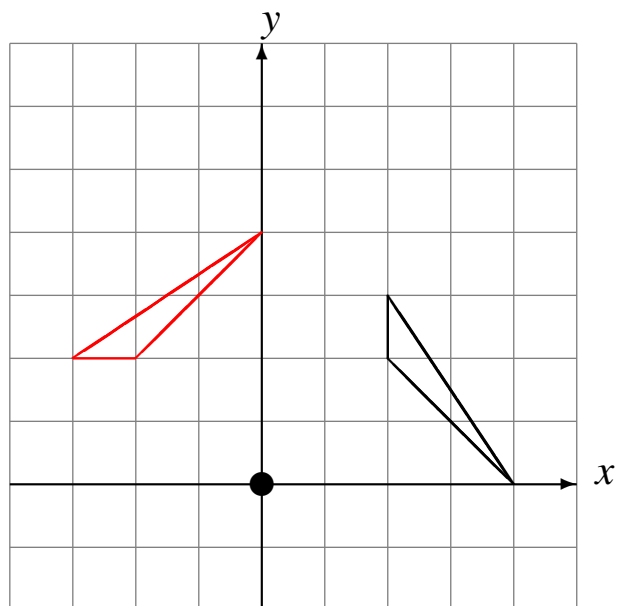

Rotations (J)

Draw the rotated image.

Rotate 180° about $(0, 0)$.

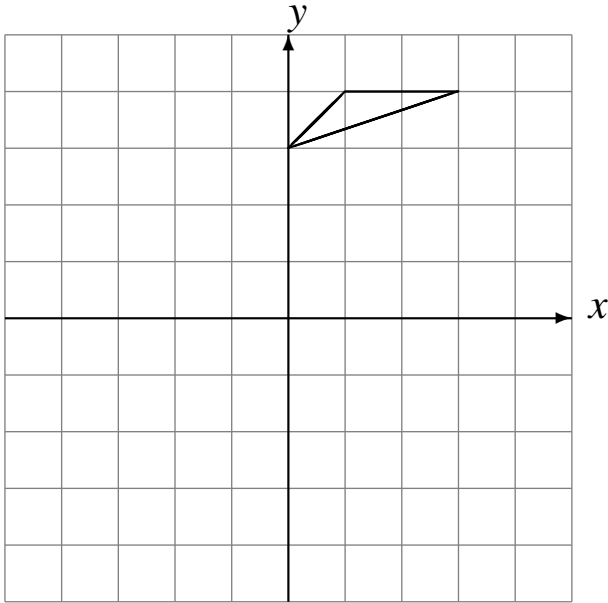

Rotate 90° clockwise about $(0, 0)$.

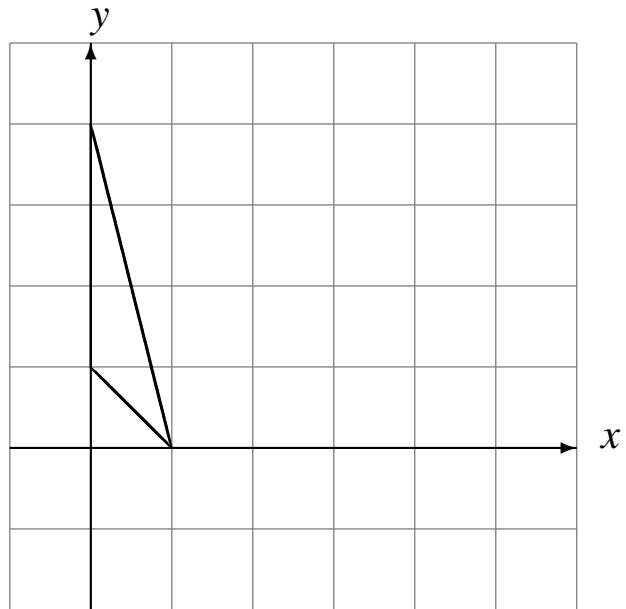

Rotate 90° clockwise about $(0, 0)$.

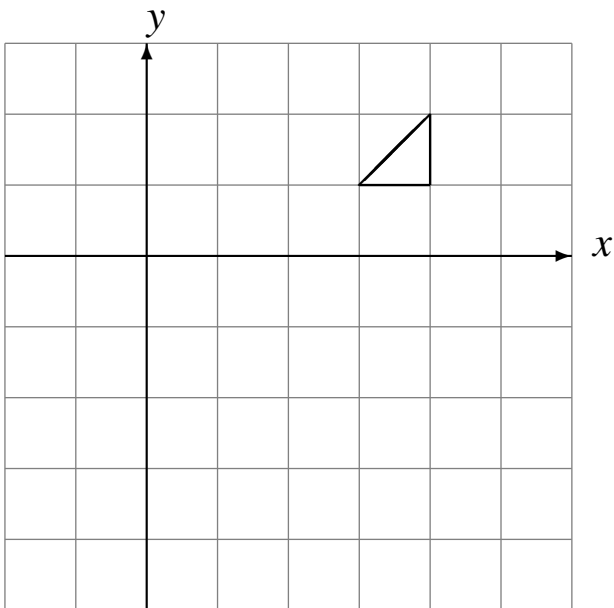

Rotate 180° about $(0, 0)$.

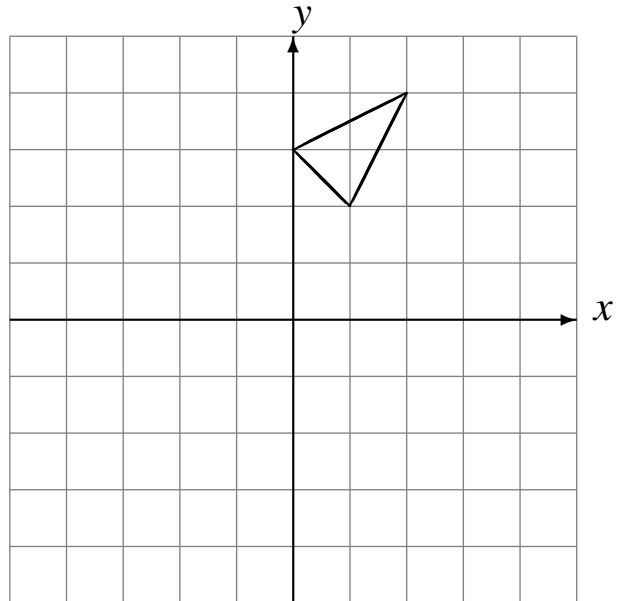

Rotations (J) Answers

Draw the rotated image.

Rotate 180° about $(0, 0)$.

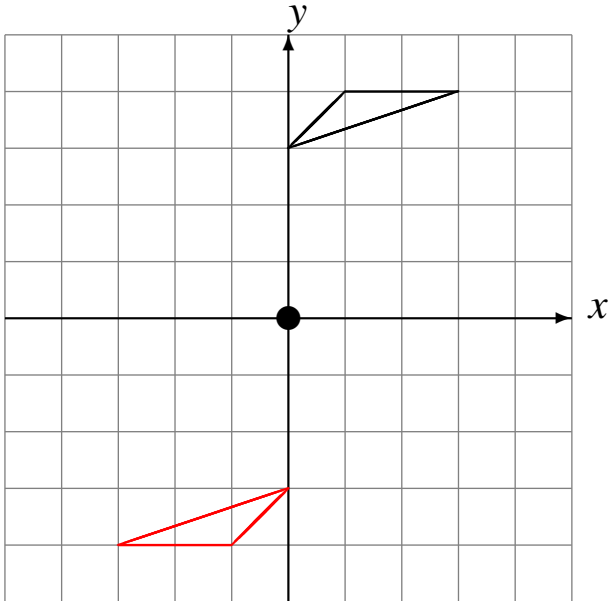

Rotate 90° clockwise about $(0, 0)$.

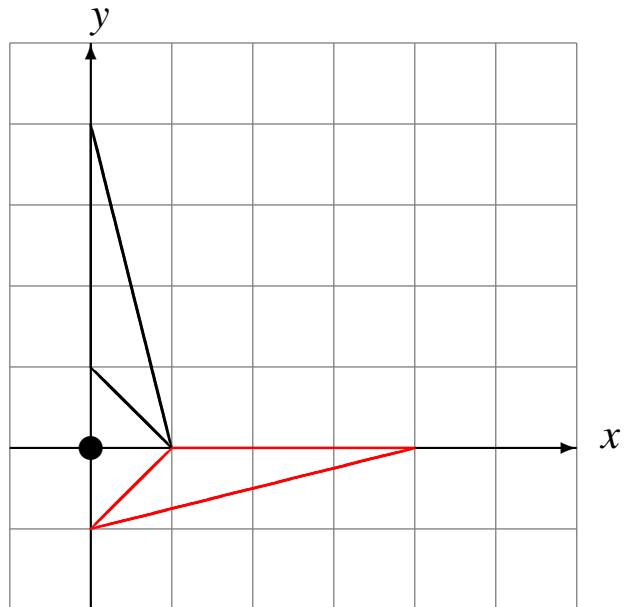

Rotate 90° clockwise about $(0, 0)$.

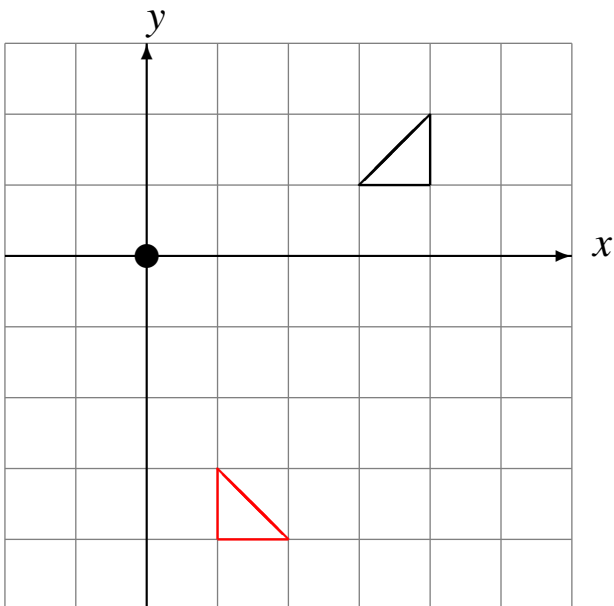

Rotate 180° about $(0, 0)$.

