

## Exterior Alternate Angles (A)

Find the alternate angle measurements for the measured angles.

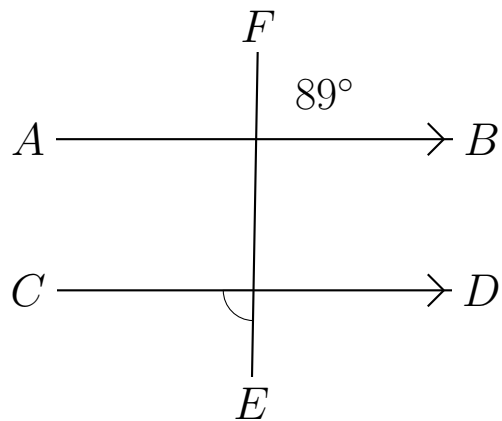
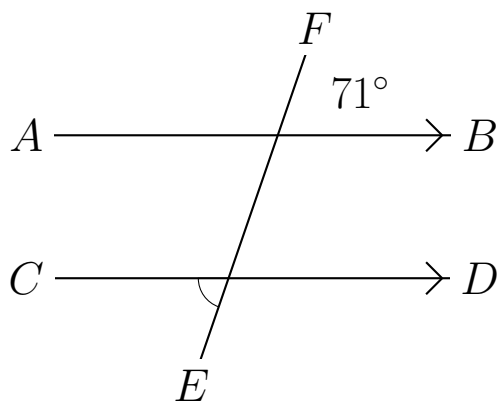
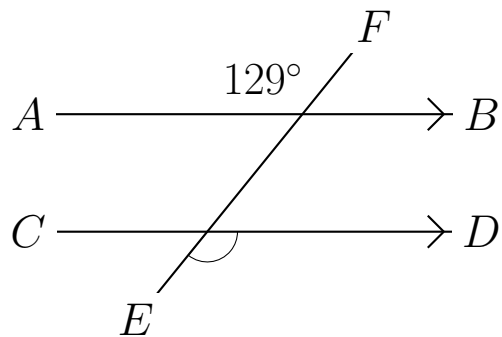
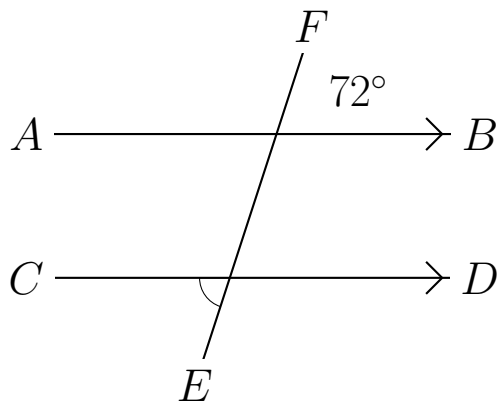
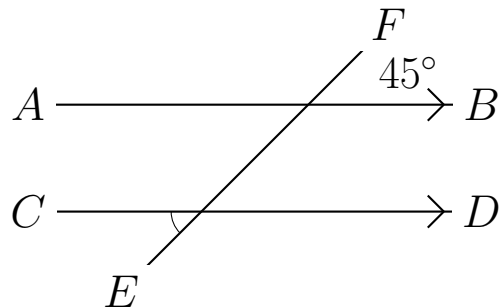
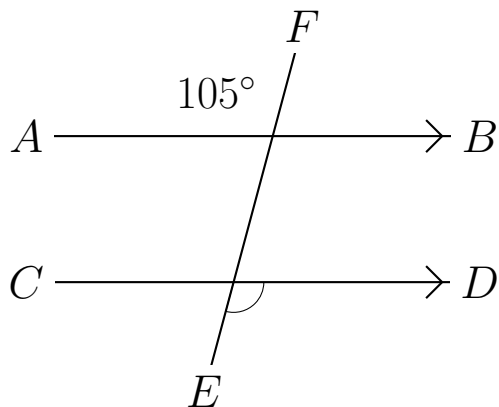

## Exterior Alternate Angles (A) Answers

Find the alternate angle measurements for the measured angles.

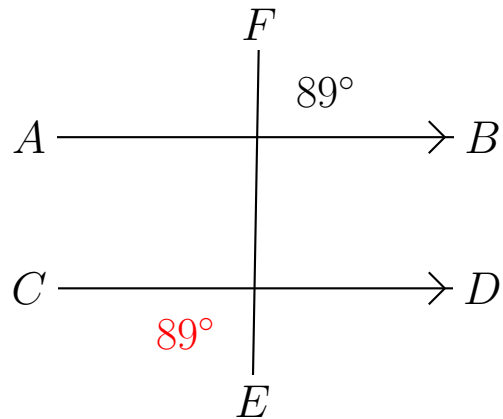
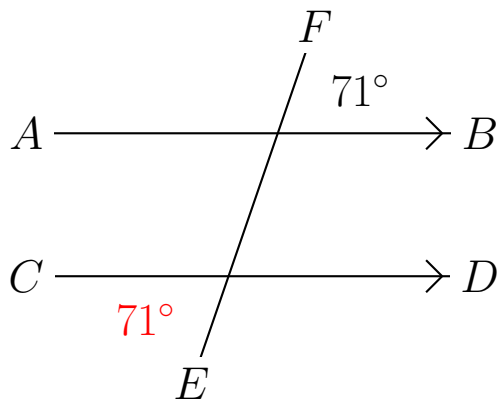
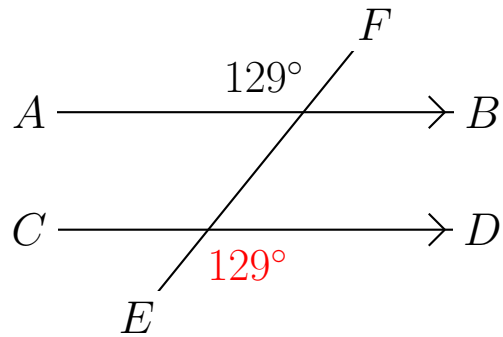
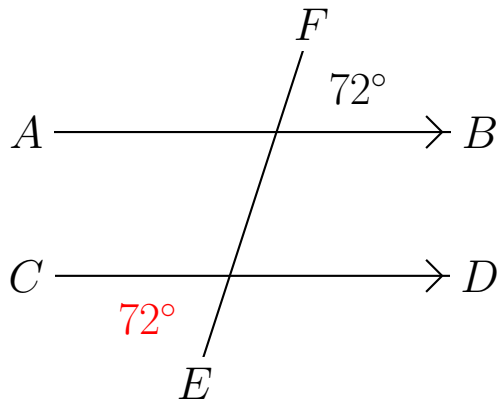
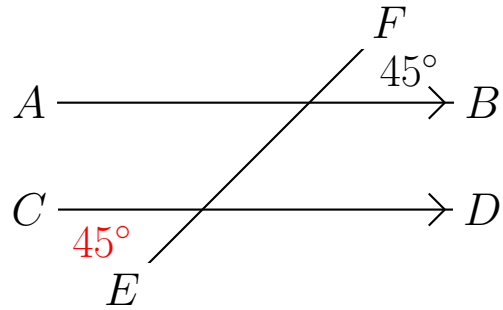
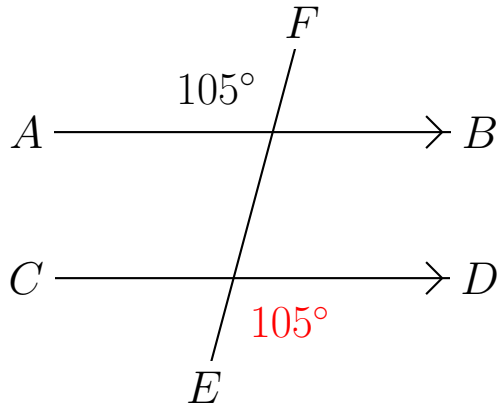

## Exterior Alternate Angles (B)

Find the alternate angle measurements for the measured angles.

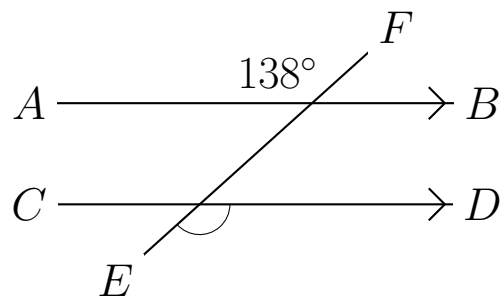
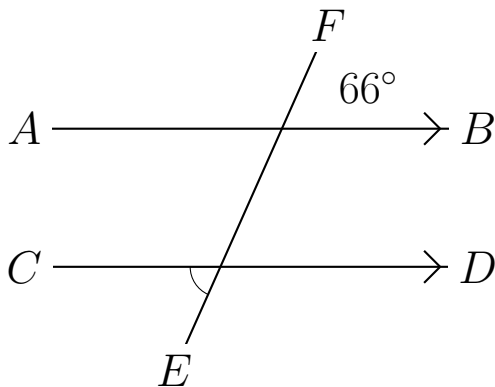
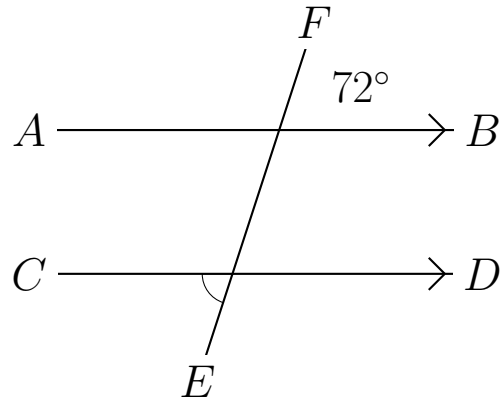
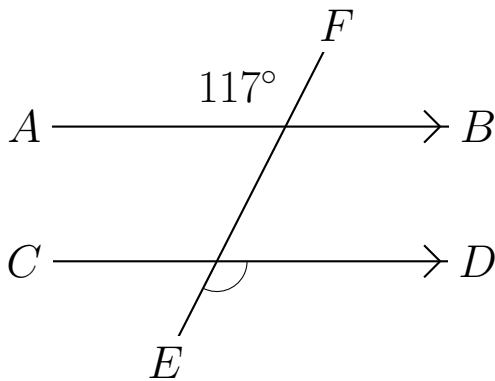
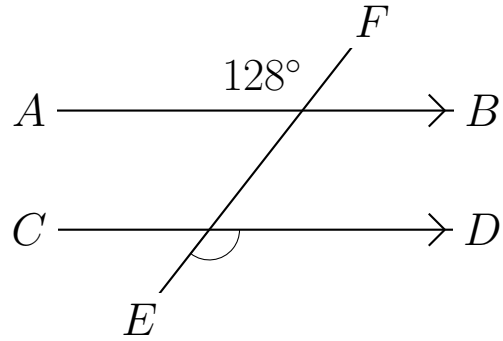
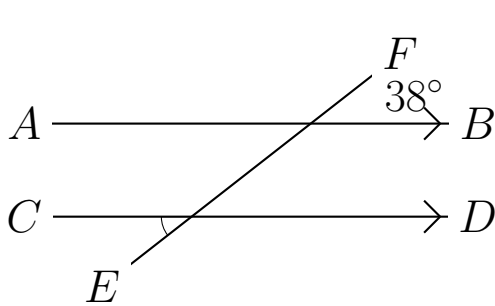

## Exterior Alternate Angles (B) Answers

Find the alternate angle measurements for the measured angles.

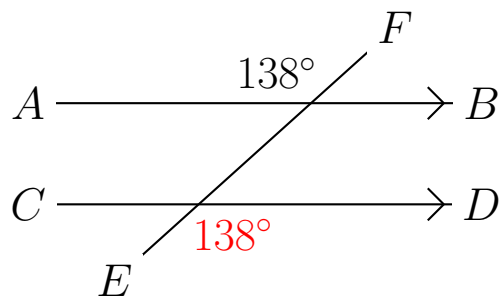
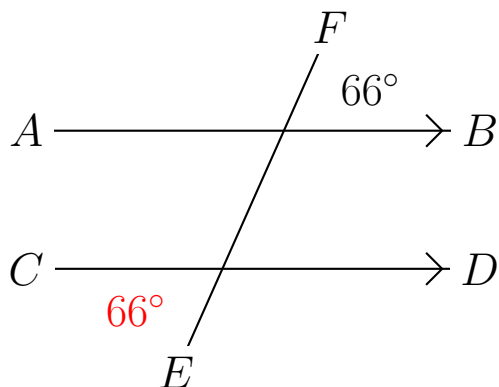
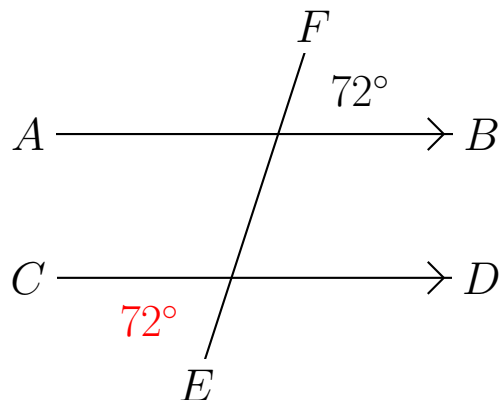
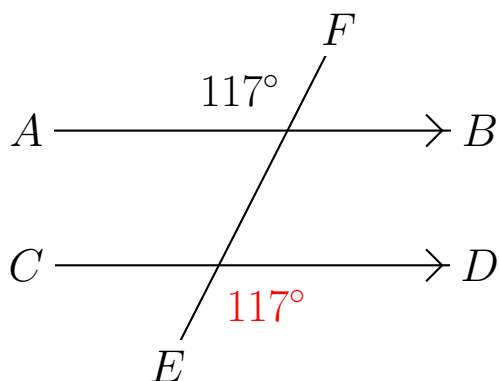
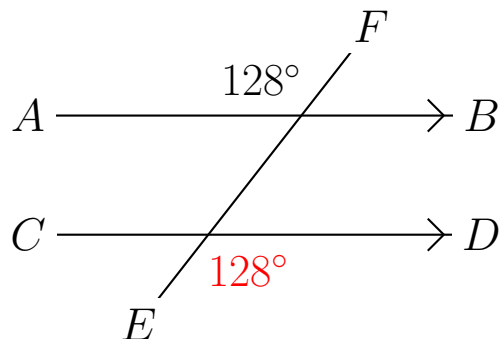
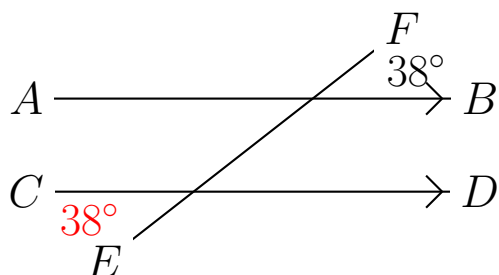

## Exterior Alternate Angles (C)

Find the alternate angle measurements for the measured angles.

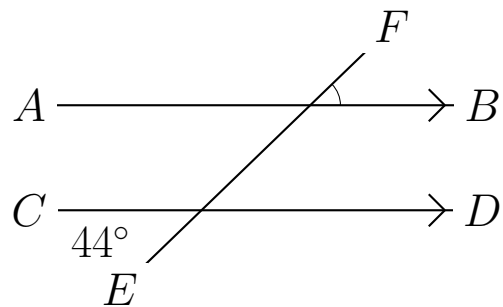
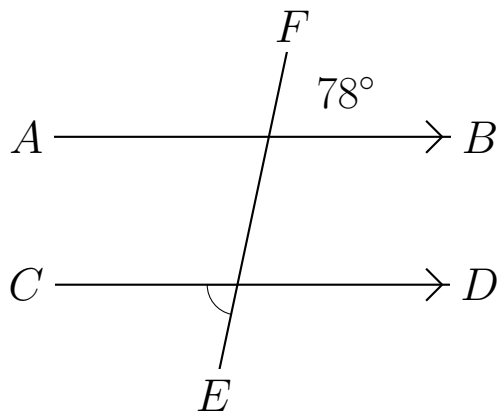
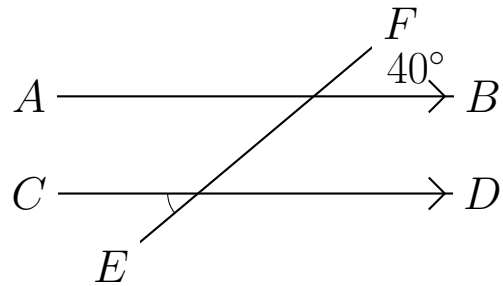
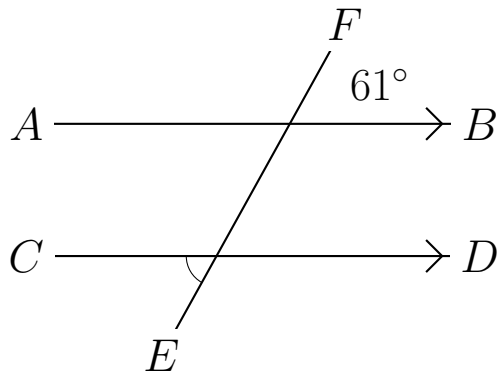
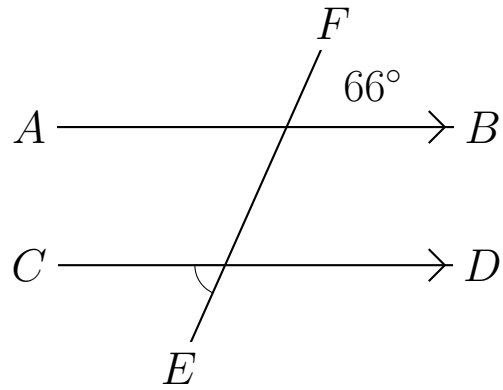
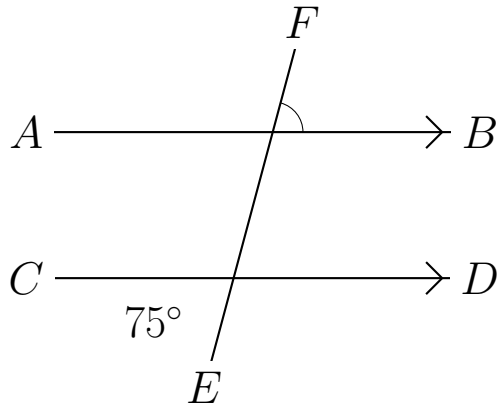

## Exterior Alternate Angles (C) Answers

Find the alternate angle measurements for the measured angles.

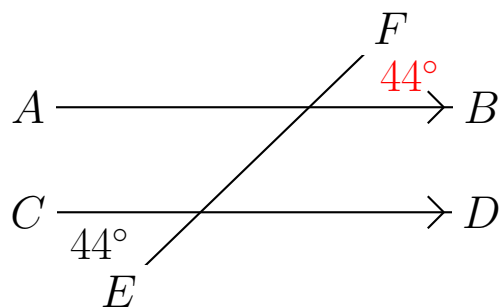
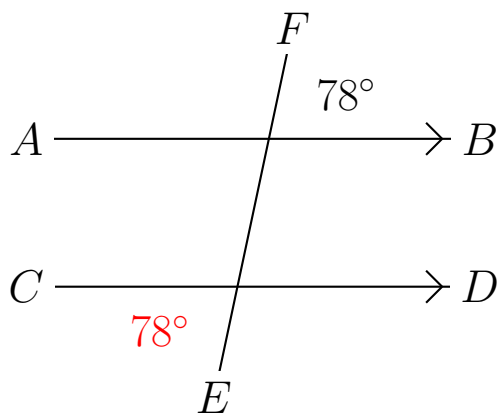
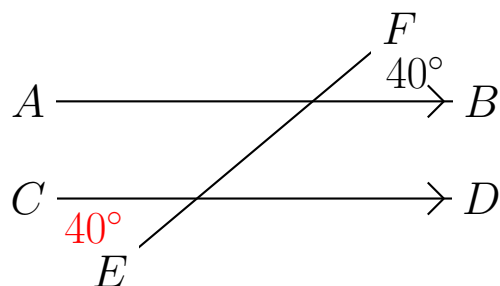
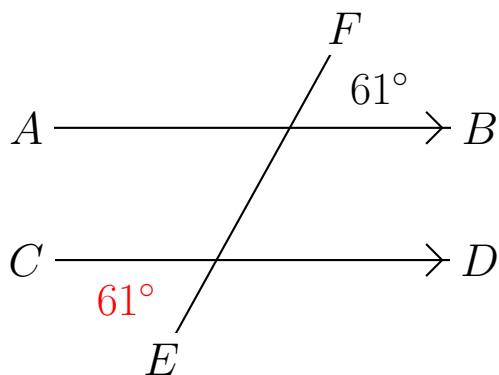
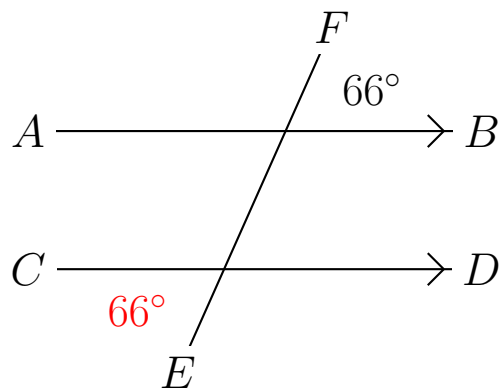
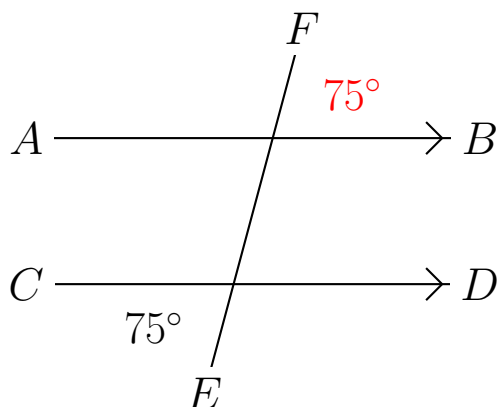

## Exterior Alternate Angles (D)

Find the alternate angle measurements for the measured angles.

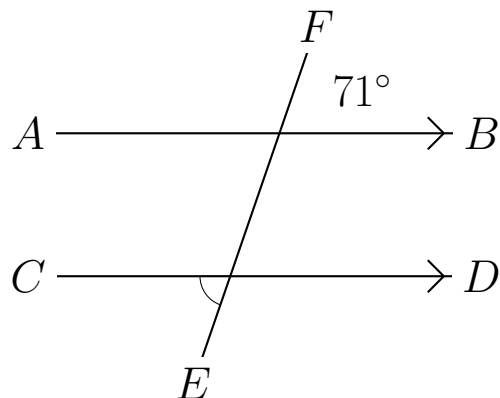
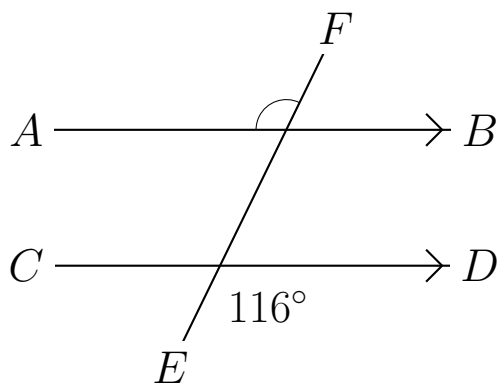
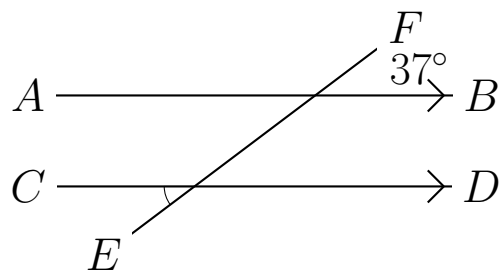
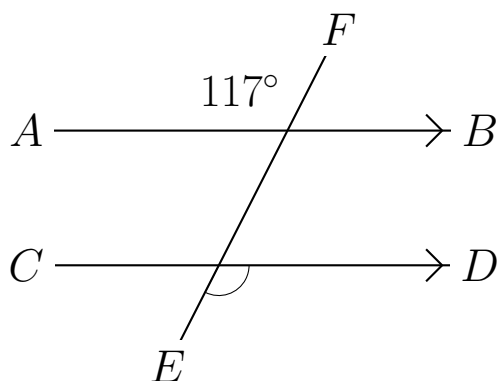
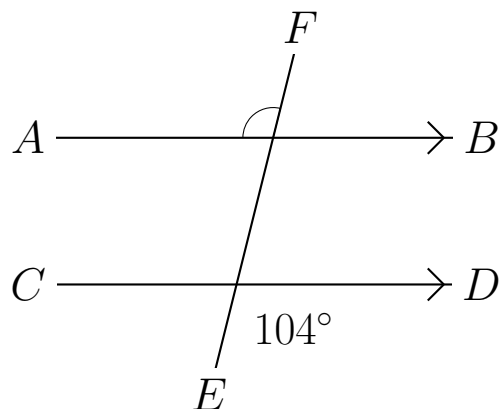
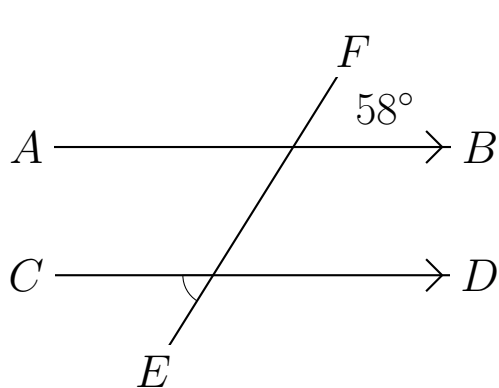

## Exterior Alternate Angles (D) Answers

Find the alternate angle measurements for the measured angles.

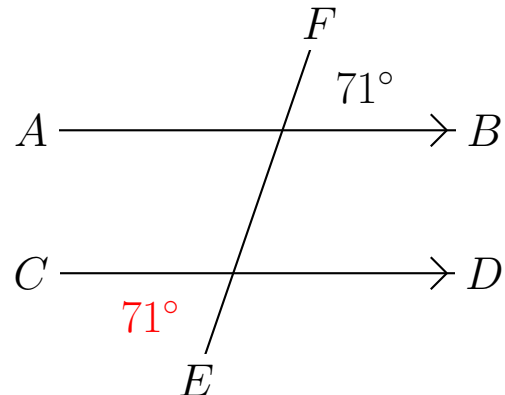
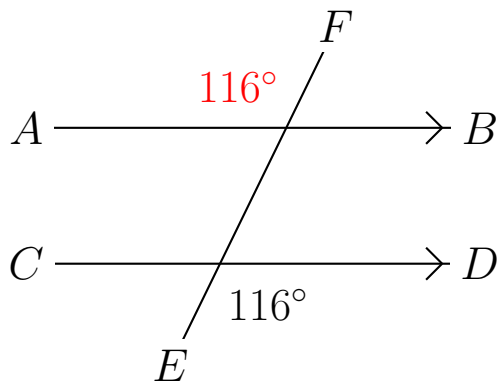
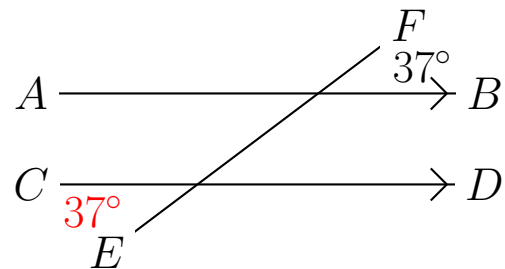
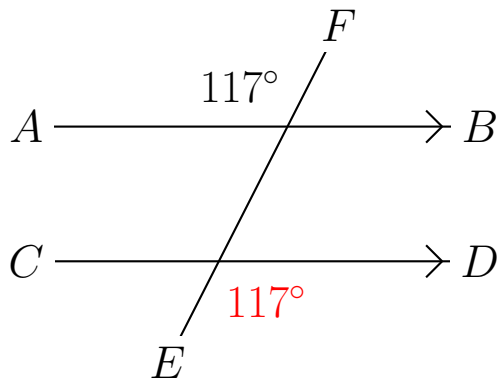
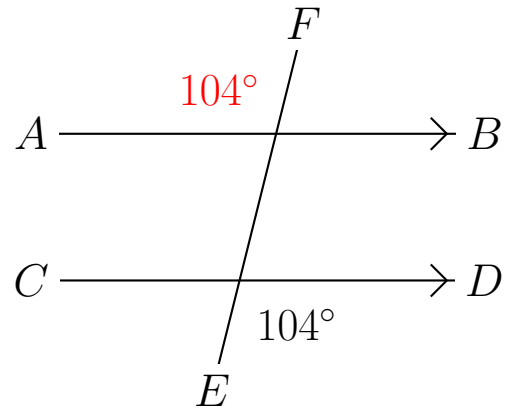
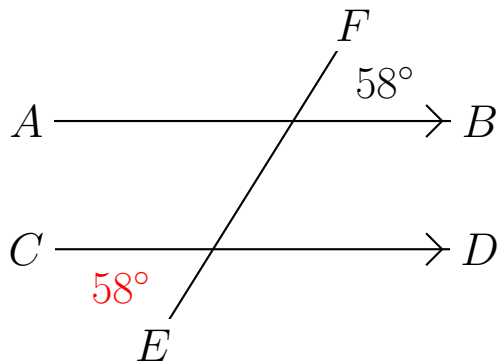



## Exterior Alternate Angles (E)

Find the alternate angle measurements for the measured angles.

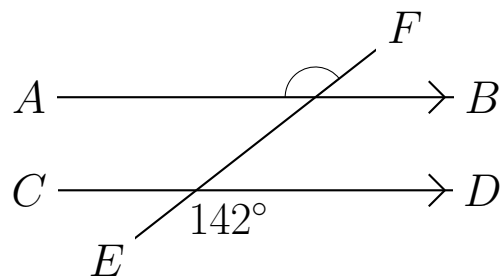
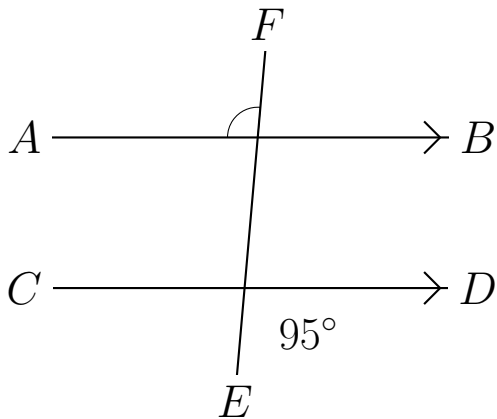
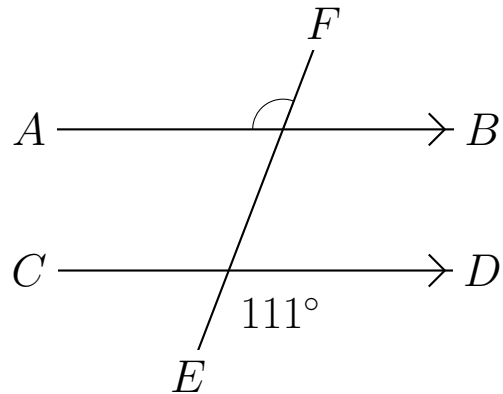
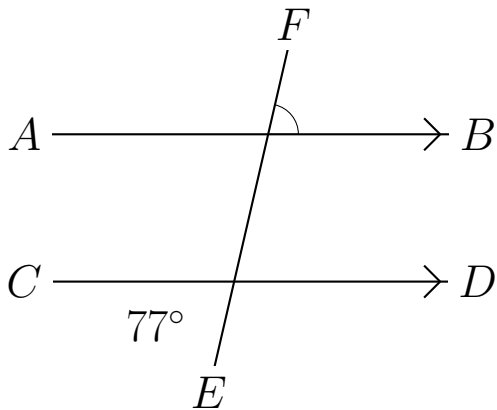
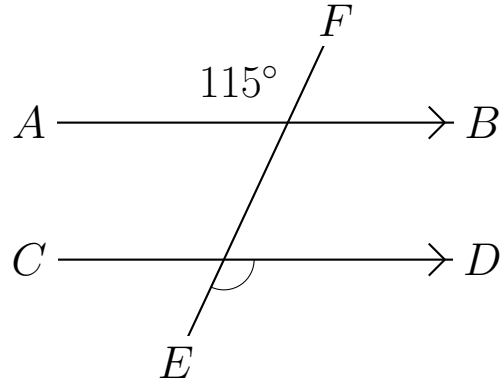
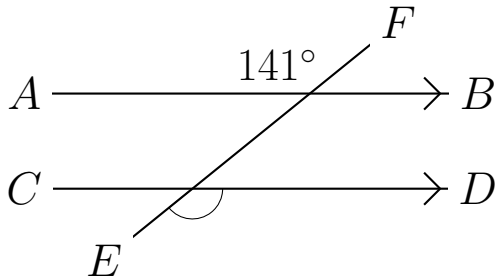

## Exterior Alternate Angles (E) Answers

Find the alternate angle measurements for the measured angles.

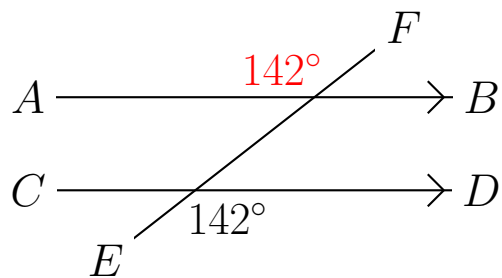
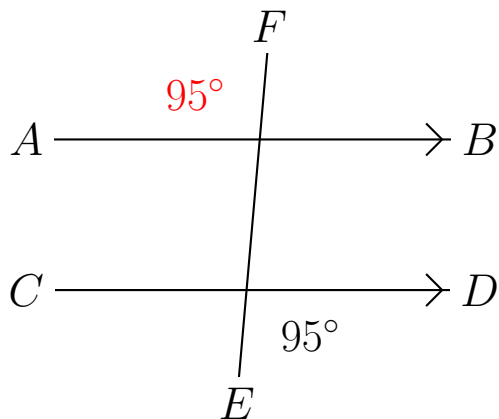
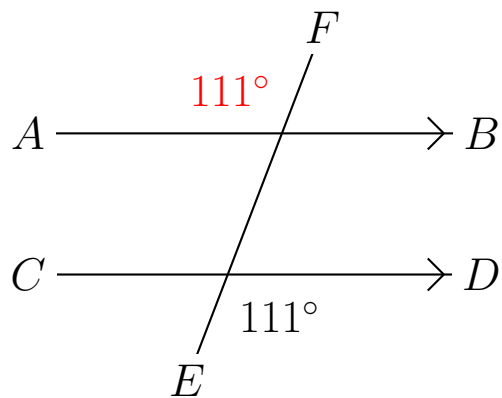
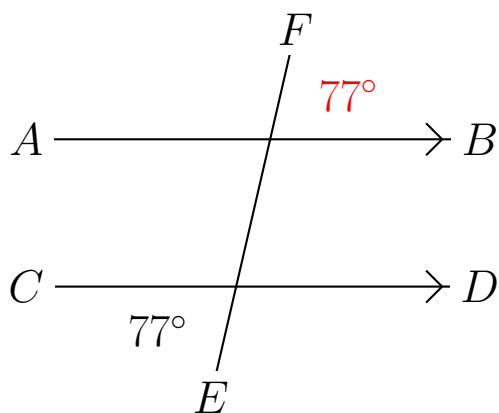
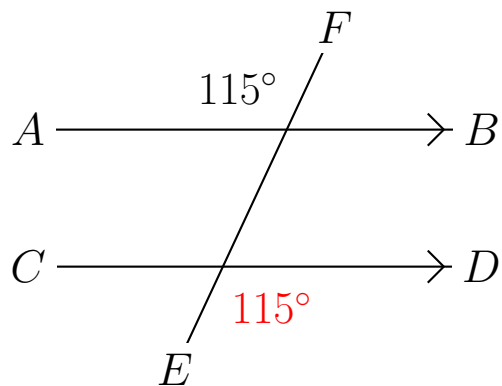
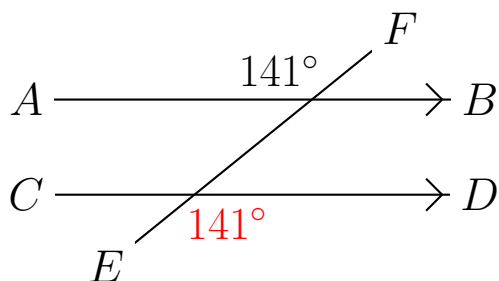

## Exterior Alternate Angles (F)

Find the alternate angle measurements for the measured angles.

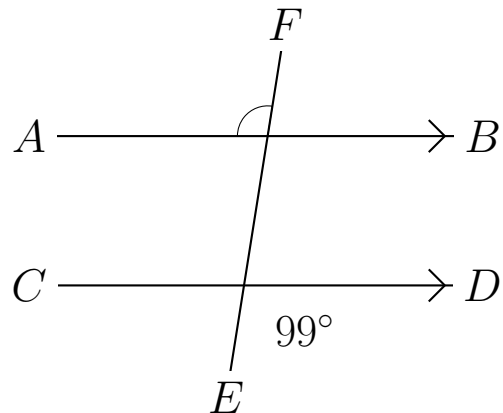
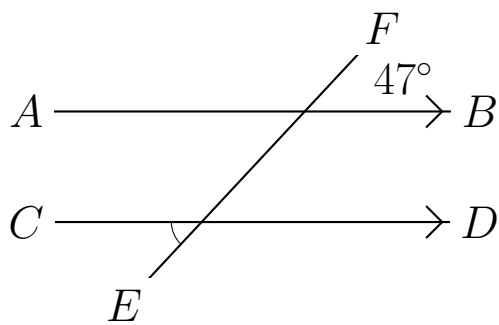
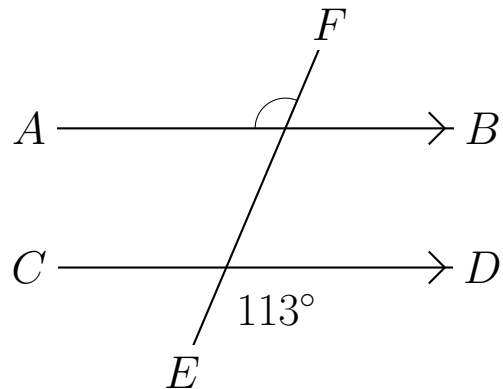
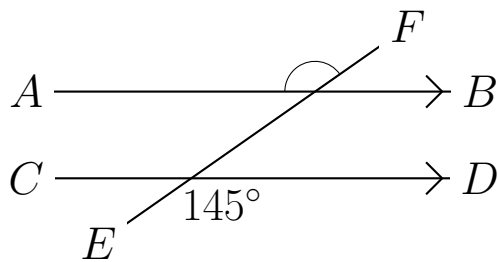
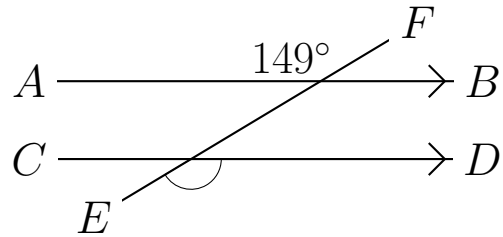
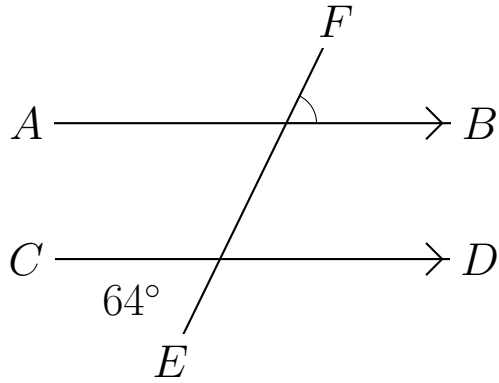

## Exterior Alternate Angles (F) Answers

Find the alternate angle measurements for the measured angles.

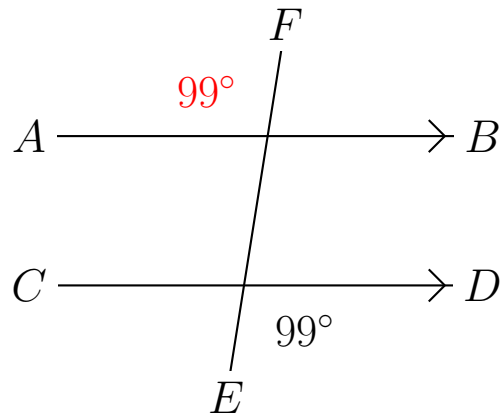
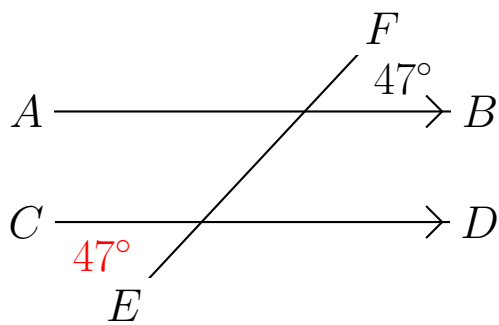
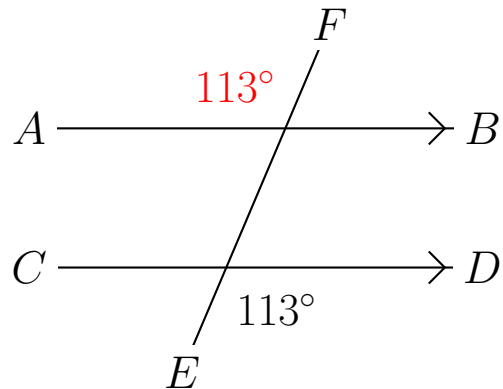
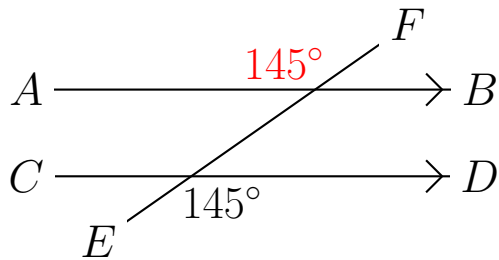
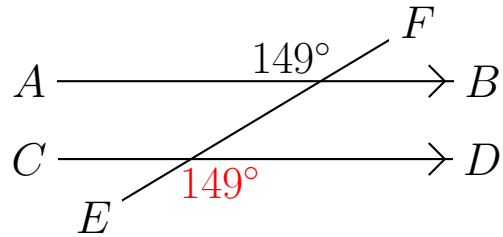
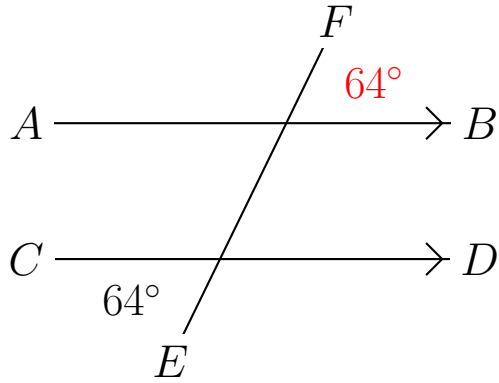

## Exterior Alternate Angles (G)

Find the alternate angle measurements for the measured angles.

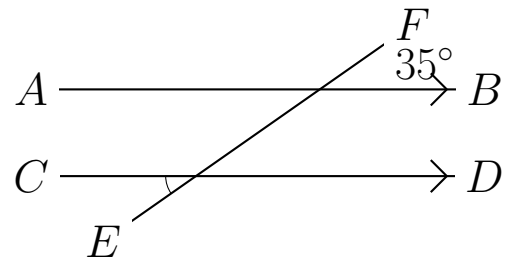
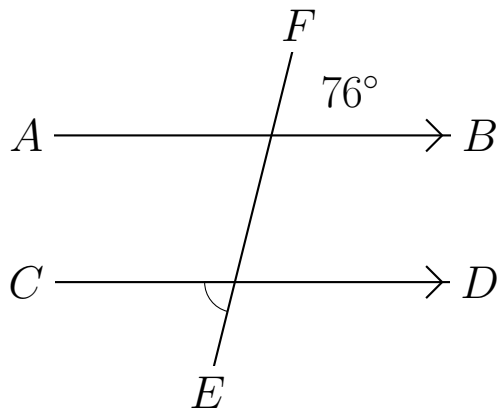
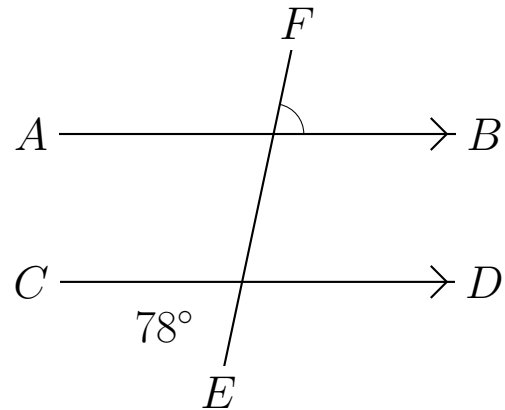
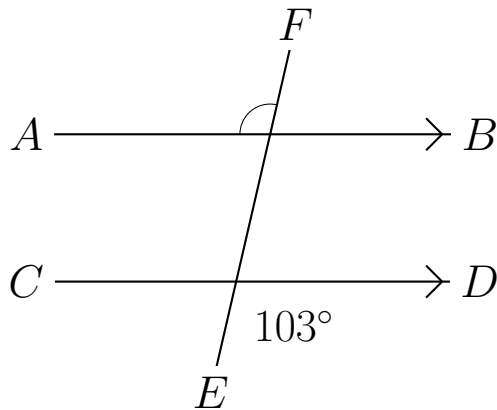
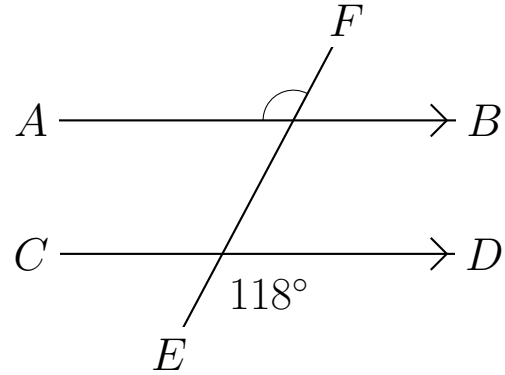
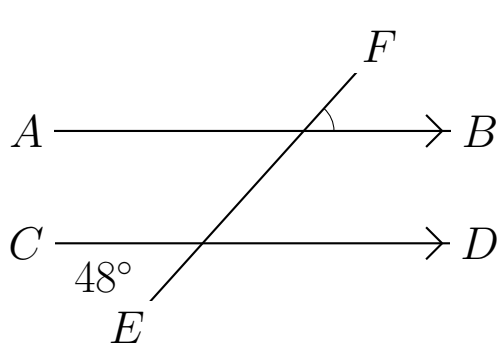

## Exterior Alternate Angles (G) Answers

Find the alternate angle measurements for the measured angles.

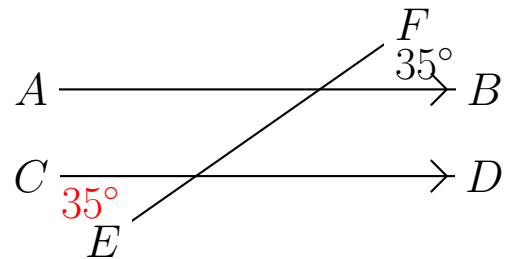
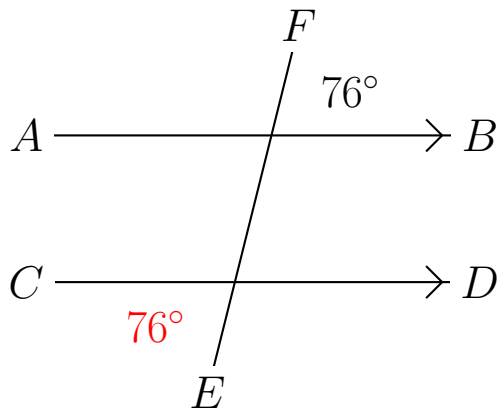
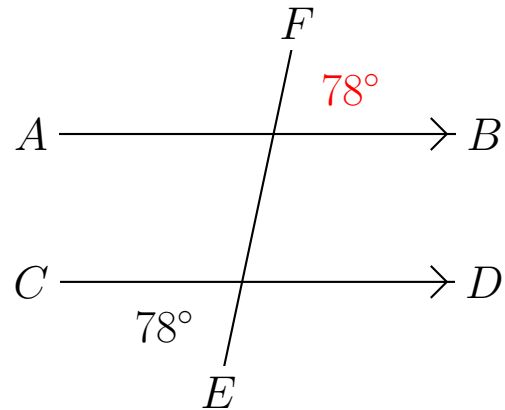
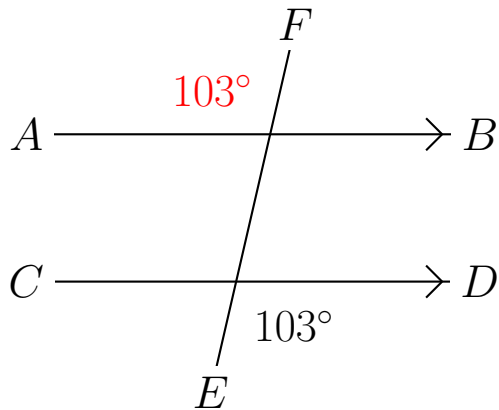
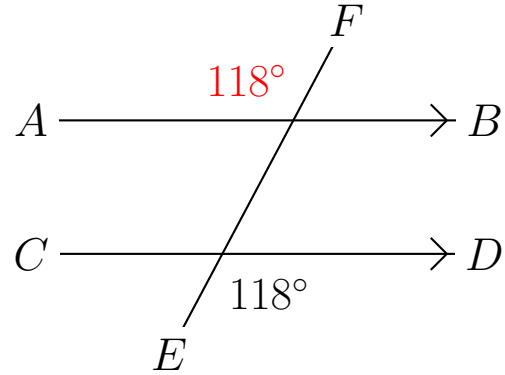
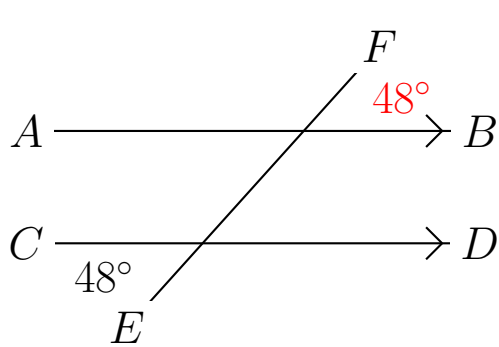

## Exterior Alternate Angles (H)

Find the alternate angle measurements for the measured angles.

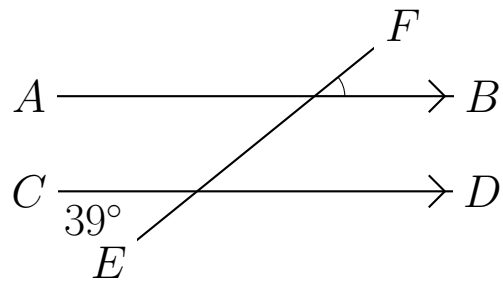
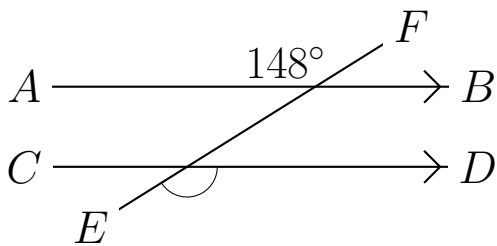
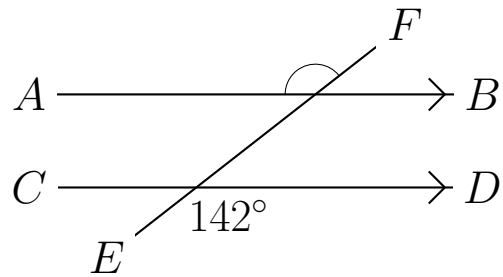
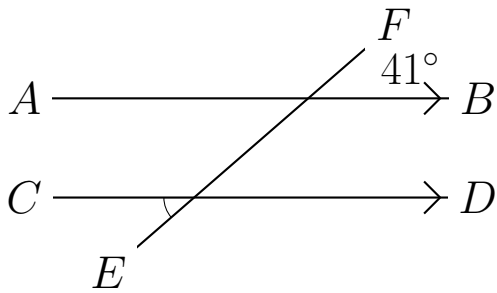
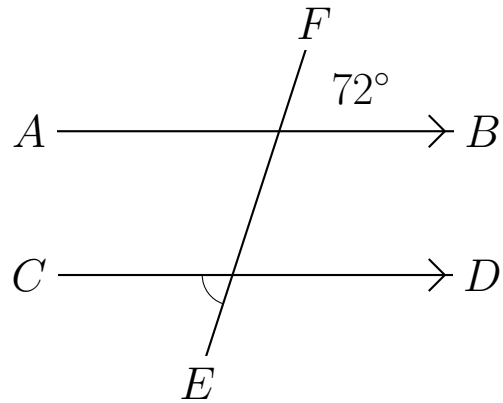
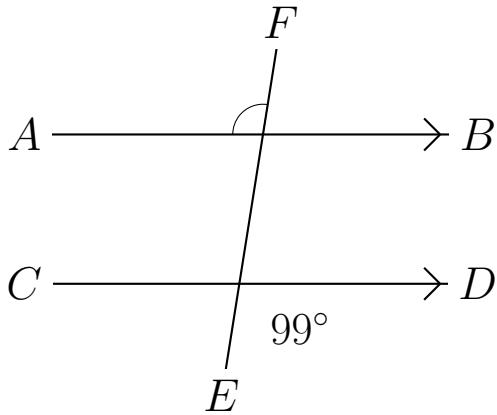

## Exterior Alternate Angles (H) Answers

Find the alternate angle measurements for the measured angles.

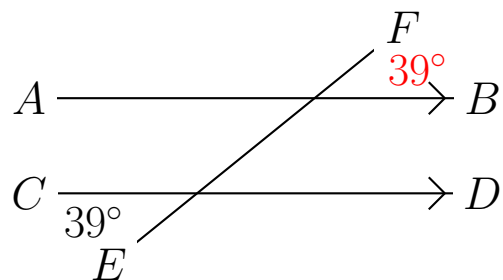
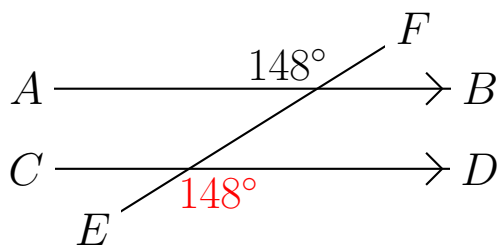
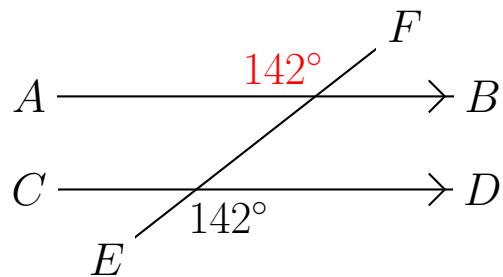
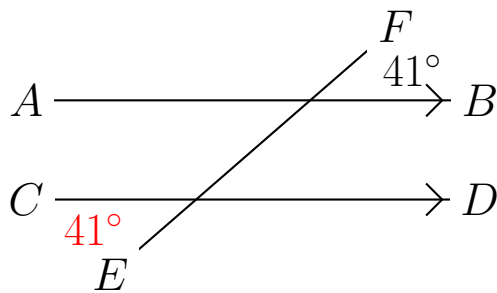
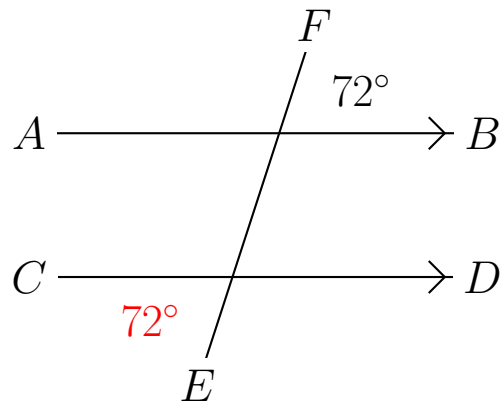
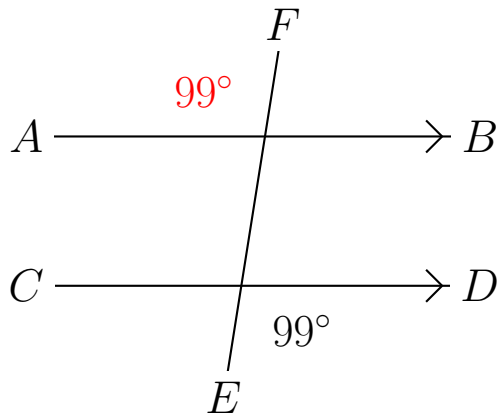



## Exterior Alternate Angles (I)

Find the alternate angle measurements for the measured angles.

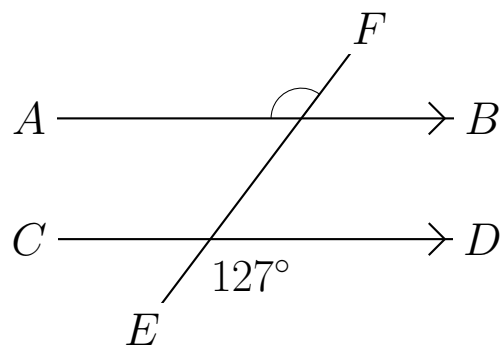
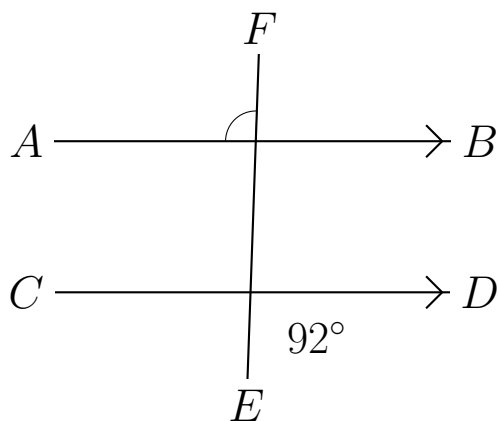
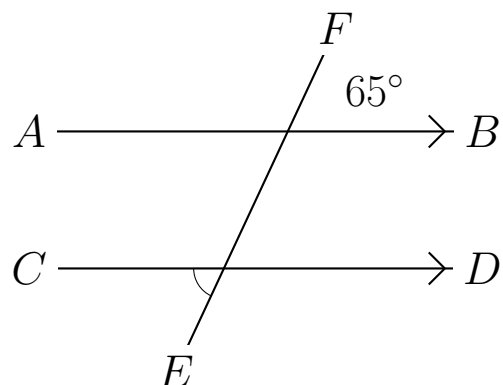
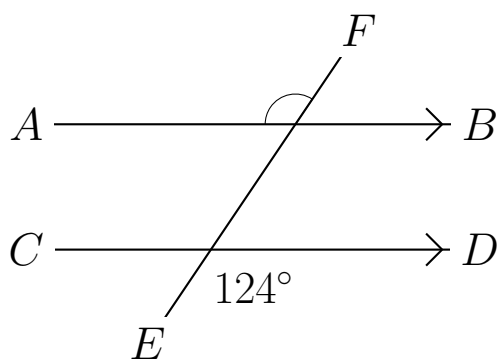
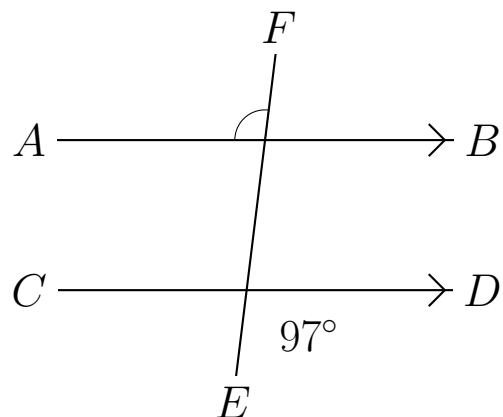
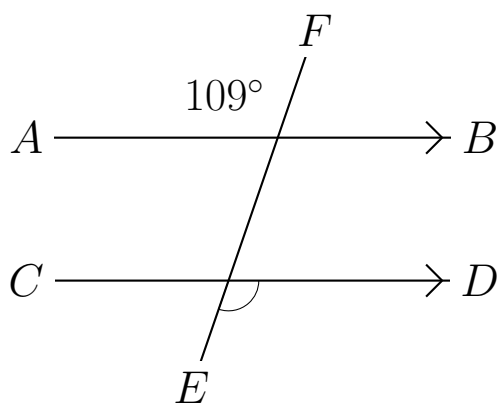

## Exterior Alternate Angles (I) Answers

Find the alternate angle measurements for the measured angles.

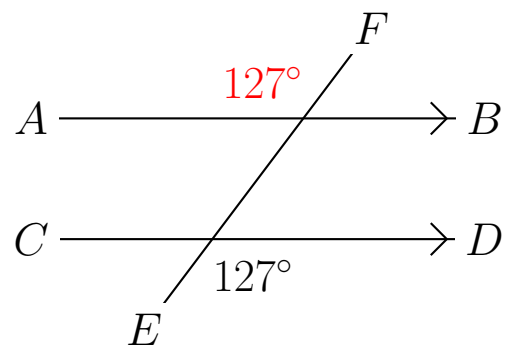
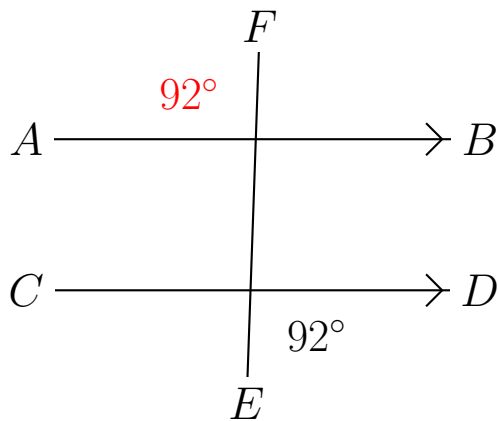
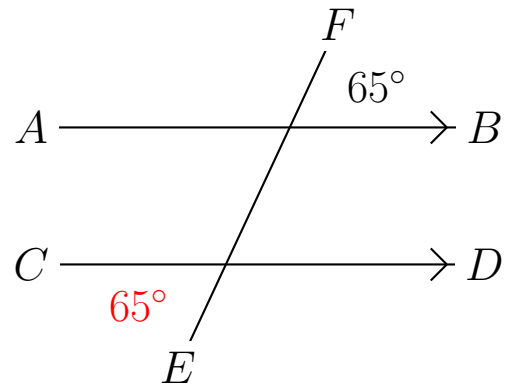
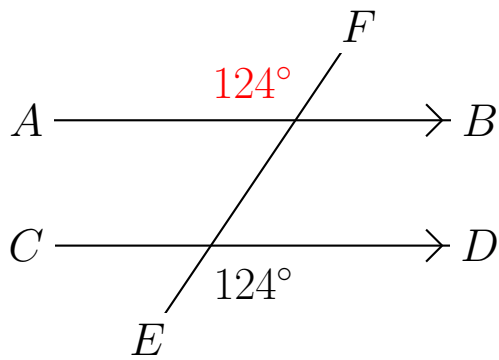
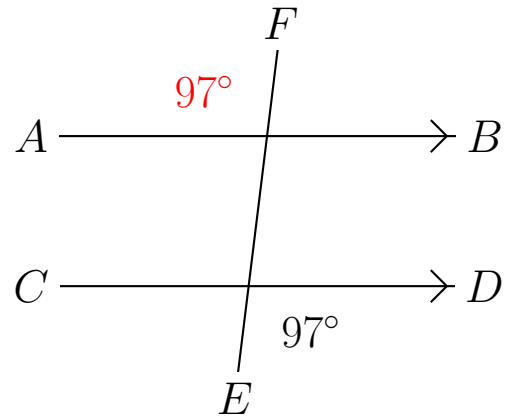
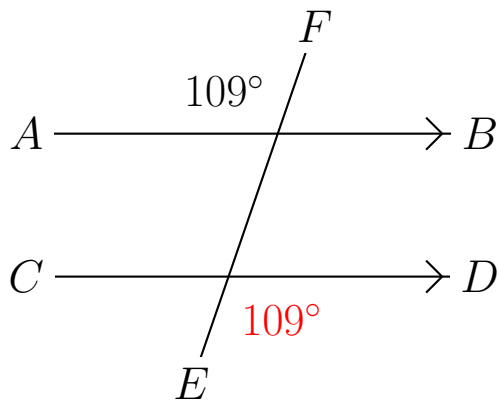

## Exterior Alternate Angles (J)

Find the alternate angle measurements for the measured angles.

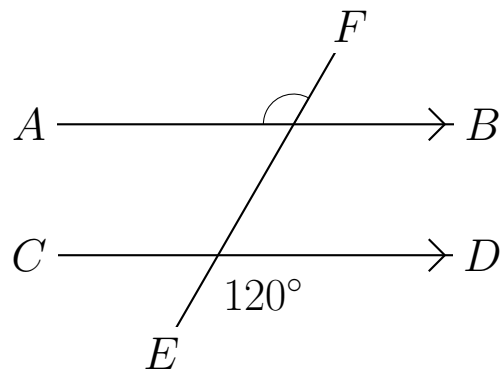
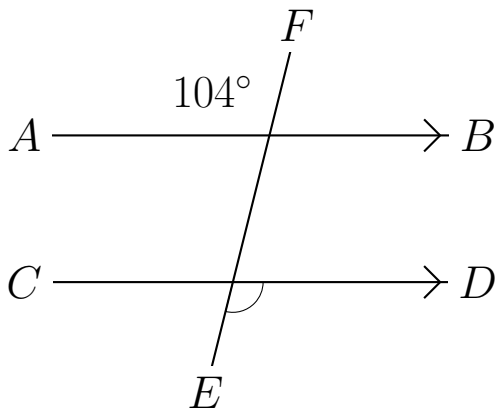
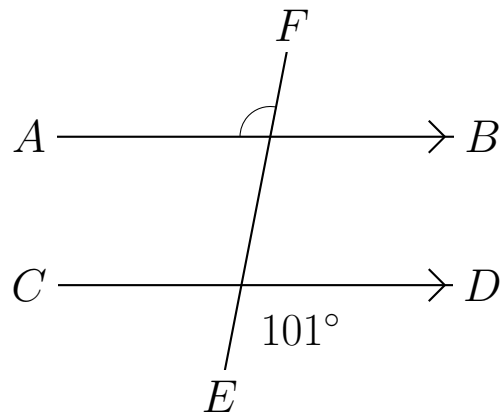
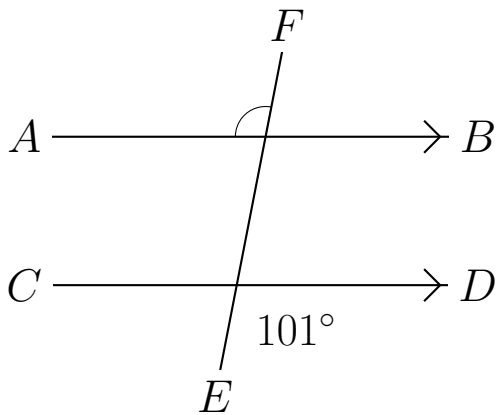
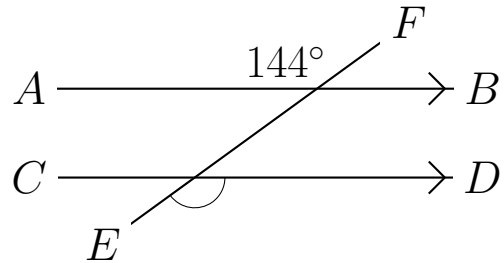
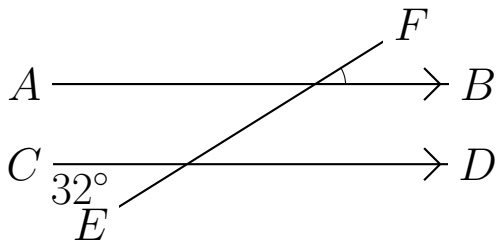

## Exterior Alternate Angles (J) Answers

Find the alternate angle measurements for the measured angles.

