

Angle Bisectors (G)

Construct the bisector for each angle.

1.

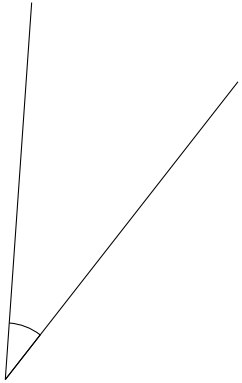

2.

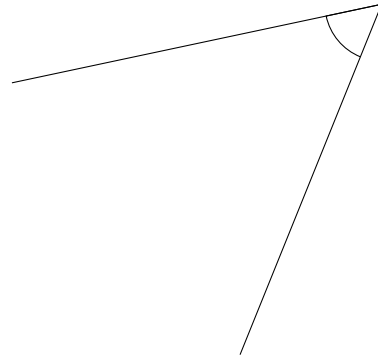

3.

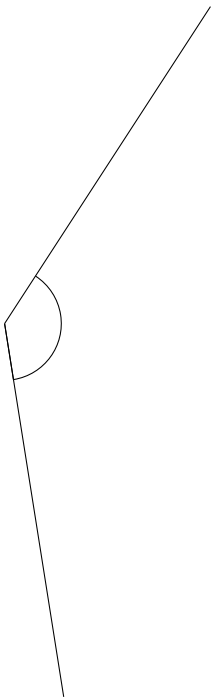

4.

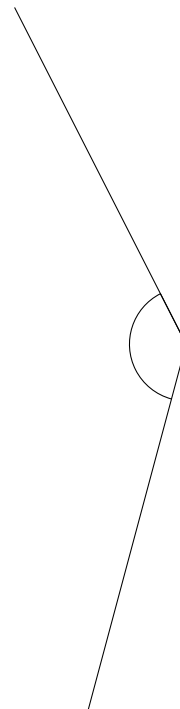

Angle Bisectors (G) Answers

Construct the bisector for each angle.

1.

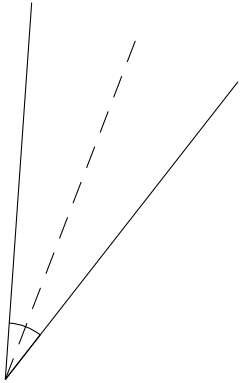

2.

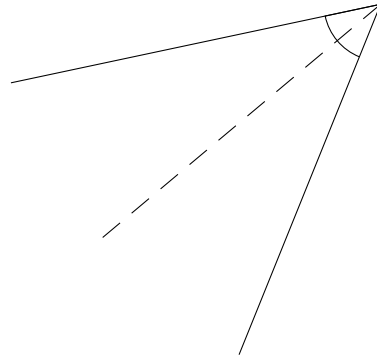

3.

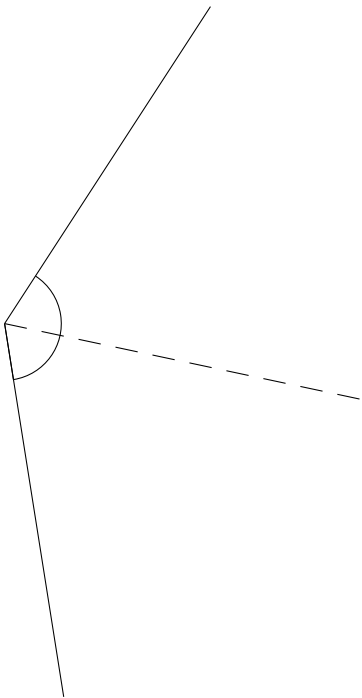

4.

